



BRADNAM'S

AWNING WINDOWS

PRODUCT INFORMATION

Product performance is subject to regional variations, design requirements and building codes. Performance parameters are independent of each other.

Images are for illustration purposes only and may not accurately represent the product. Bradnam's Windows & Doors reserves the right to change, alter or delete any aspect of this product without notice.



PERFORMANCE PARAMETERS

CONFIGURATIONS

STANDARD SIZES

COLONIAL BAR OPTIONS

PROFILE DIMENSIONS

REVEAL SETBACKS

SILL REBATES

PERFORMANCE PARAMETERS

	Essential	Signature	Commercial
Frame size	52mm	100mm	100mm
Maximum panel height	2400mm	2400mm	2400mm
Maximum window width	5340mm	5350mm	5350mm
Maximum panel width	2150mm	2750mm	2750mm
Maximum panel weight	74kg	74kg	74kg
Maximum water rating	600Pa	600Pa	600Pa
Maximum wind rating	4500Pa ULS	4500Pa ULS	4500Pa ULS
Maximum glass thickness (single glazed)	12.76mm	12.76mm	12.76mm
Maximum glass thickness (double glazed)	24mm	24mm	24mm
Maximum acoustic rating	Rw37	Rw38	Rw38
Maximum bushfire rating	BAL 40	BAL 40	BAL 40
Lowest U-value (single glazed)	5.0	5.4	5.6
Lowest U-value (double glazed)	3.3	3.3	4.2

Note: Performance figures are independent of each other and subject to conditions. Contact a Bradnam's Windows & Doors representative to discuss your specific project requirements.

CONFIGURATIONS

Standard

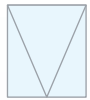

A

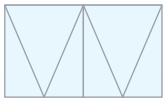

AA

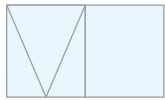

AF

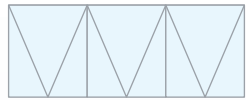

AAA

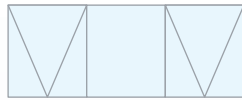

AFA

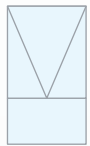

A/F

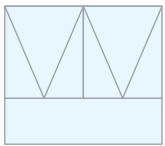

AA/F

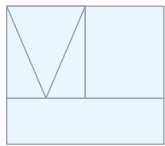

AF/F

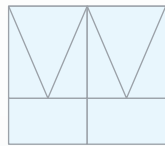

AA/FF

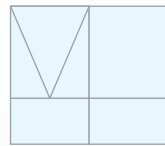

AF/FF

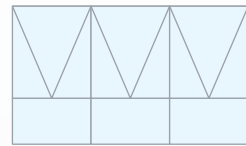

AAA/FFF

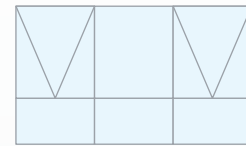

AFA/FFF

Designer



A

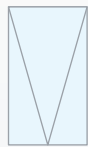

A

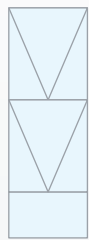

A/A/F

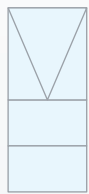

A/F/F

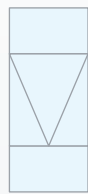

F/A/F

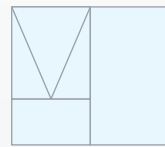

A/F-F

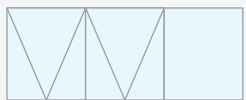

AAF



AFF



AAAA



AFFA



































































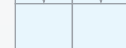

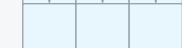
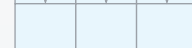
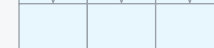
Other Designer configurations available

STANDARD SIZES – QUEENSLAND

The availability of certain sizes and configurations is dependent on the design wind load requirement as per AS2047-2014. Check with your Bradnam's representative to confirm availability. Awning Windows may be subject to local variation or regulatory requirements.

 Available Single or Double Glazed

Note: All Awning Window sashes come standard with a chain winder









































































STUD OPENING mm		660	960	1260	1560	1860	2160	2460	2760	3060
FRAME SIZE mm		610	910	1210	1510	1810	2110	2410	2710	3010
650	600	 A0606	 A0609	 AA0612	 AA0615	 AA0618	 AAA0621	 AAA0624	 AAA0627	 AAA0630
	950	 A0906	 A0909	 AA0912	 AA0915	 AA0918	 AAA0921	 AAA0924	 AAA0927	 AAA0930
1050	1000	 A1006	 A1009	 AA1012	 AA1015	 AA1018	 AAA1021	 AAA1024	 AAA1027	 AAA1030
	1250	 A1206	 A1209	 AA1212	 AA1215	 AA1218	 AAA1221	 AAA1224	 AAA1227	 AAA1230
1550	1500	 A1506	 A1509	 AA1512	 AA1515	 AA1518	 AAA1521	 AAA1524	 AAA1527	 AAA1530
	1850	 A/F1806	 A/F1809	 AA/F1812	 AA/FF1815	 AA/FF1818	 AAA/FFF1821	 AAA/FFF1824	 AAA/FFF1827	 AAA/FFF1830
2150	1800	 A/F1806	 A/F1809	 AA/F1812	 AA/FF1815	 AA/FF1818	 AAA/FFF1821	 AAA/FFF1824	 AAA/FFF1827	 AAA/FFF1830
	2100	 A/F2106	 A/F2109	 AA/F2112	 AA/FF2115	 AA/FF2118	 AAA/FFF2121	 AAA/FFF2124	 AAA/FFF2127	 AAA/FFF2130

STANDARD SIZES – NEW SOUTH WALES

The availability of certain sizes and configurations is dependent on the design wind load requirement as per AS2047-2014. Check with your Bradnam's representative to confirm availability. Awning Windows may be subject to local variation or regulatory requirements.

 Available Single or Double Glazed

















































































Note: All Awning Window sashes come standard with a chain winder

STUD OPENING mm		670	910	1270	1630	1870	2230	2470	2710	3070
FRAME SIZE mm		610	850	1210	1570	1810	2170	2410	2650	3010
660	600	 W0606	 W0609	 WF0612	 WF0616	 WF0618	 WFW0622	 WFW0624	 WFW0627	 WFW0630
920	860	 W0906	 W0909	 WF0912	 WF0916	 WF0918	 WFW0922	 WFW0924	 WFW0927	 WFW0930
1090	1030	 W1006	 W1009	 WF1012	 WF1016	 WF1018	 WFW1022	 WFW1024	 WFW1027	 WFW1030
1260	1200	 W1206	 W1209	 WF1212	 WF1216	 WF1218	 WFW1222	 WFW1224	 WFW1227	 WFW1230
1430	1370	 W1406	 W1409	 WF1412	 WF1416	 WF1418	 WFW1422	 WFW1424	 WFW1427	 WFW1430
1520	1460	 W1506	 W1509	 WF1512	 WF1516	 WF1518	 WFW1522	 WFW1524	 WFW1527	 WFW1530
1860	1800	 W/F1806	 W/F1809	 WF/F1812	 WF/FF1816	 WF/FF1818	 WFW/FFF1822	 WFW/FFF1824	 WFW/FFF1827	 WFW/FFF1830
2120	2060	 W/F2106	 W/F2109	 WF/F2112	 WF/FF2116	 WF/FF2118	 WFW/FFF2122	 WFW/FFF2124	 WFW/FFF2127	 WFW/FFF2130

STANDARD SIZES – VICTORIA

The availability of certain sizes and configurations is dependent on the design wind load requirement as per AS2047-2014. Check with your Bradnam's representative to confirm availability. Awning Windows may be subject to local variation or regulatory requirements.

Note: All Awning Window sashes come standard with a chain winder

STUD OPENING mm		670	910	1270	1510	1870	2230	2470	2710	3070
FRAME SIZE mm		610	850	1210	1450	1810	2170	2410	2650	3010
660	600	 A0606	 A0609	 AF0612	 AF0615	 AF0618	 AFA0621	 AFA0624	 AFA0627	 AFA0630
920	860	 A0906	 A0909	 AF0912	 AF0915	 AF0918	 AFA0921	 AFA0924	 AFA0927	 AFA0930
1090	1030	 A1006	 A1009	 AF1012	 AF1015	 AF1018	 AFA1021	 AFA1024	 AFA1027	 AFA1030
1260	1200	 A1206	 A1209	 AF1212	 AF1215	 AF1218	 AFA1221	 AFA1224	 AFA1227	 AFA1230
1520	1460	 A1406	 A1409	 AF1412	 AF1415	 AF1418	 AFA1421	 AFA1424	 AFA1427	 AFA1430
1860	1800	 A1806T	 A1809T	 AF1812T	 AF1815T	 AF1818T	 AFA1821T	 AFA1824T	 AFA1827T	 AFA1830T
	600	 A1806T	 A1809T	 AF1812T	 AF1815T	 AF1818T	 AFA1821T	 AFA1824T	 AFA1827T	 AFA1830T
2120	2060	 A2006T	 A2009T	 AF2012T	 AF2015T	 AF2018T	 AFA2021T	 AFA2024T	 AFA2027T	 AFA2030T
	600	 A2006T	 A2009T	 AF2012T	 AF2015T	 AF2018T	 AFA2021T	 AFA2024T	 AFA2027T	 AFA2030T

COLONIAL BAR OPTIONS

Design Options

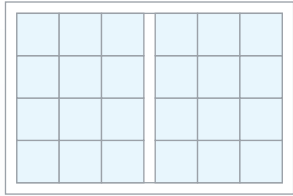

AA1218
Traditional Colonial

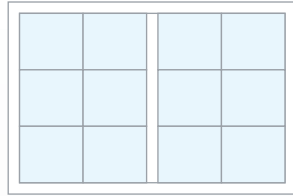

AA1218
Australian Colonial

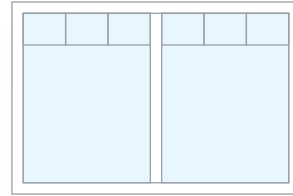

AA1218
Highlander

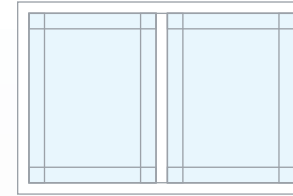

AA1218
Traditional Federation

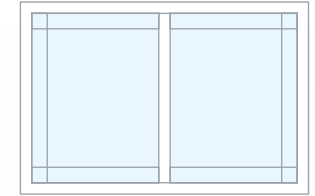

AA1218
Australian Federation

Types of Colonial Bar

Scale 5:1

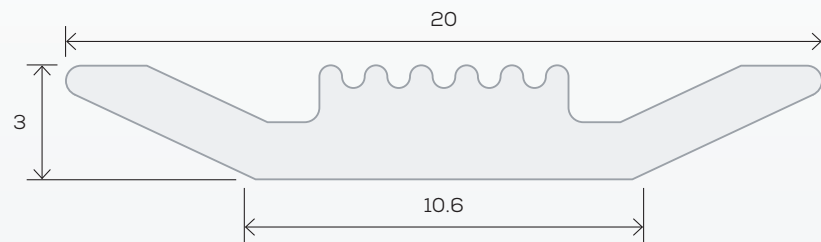

Raised



Flat

PROFILE DIMENSIONS

Note: Diagrams are not to scale. They are illustrations only, and may not accurately represent the product. Their purpose is to show the profile dimensions.

Single Glazed

Essential

Double Glazed

External View

Internal View

External View

Internal View

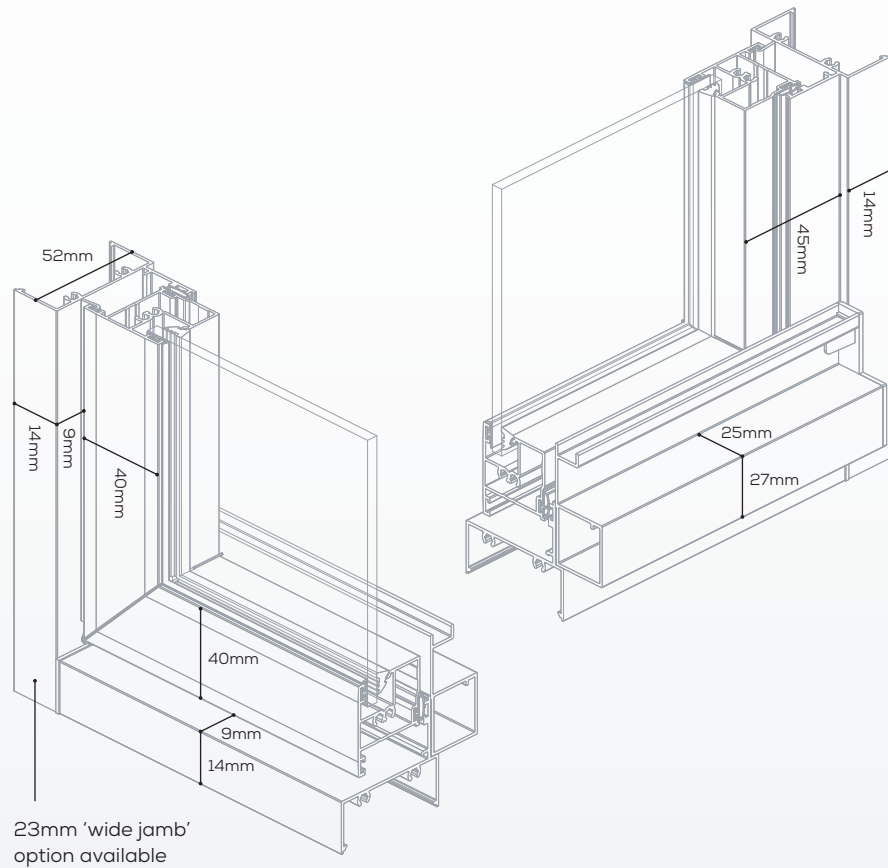

33mm sash shown

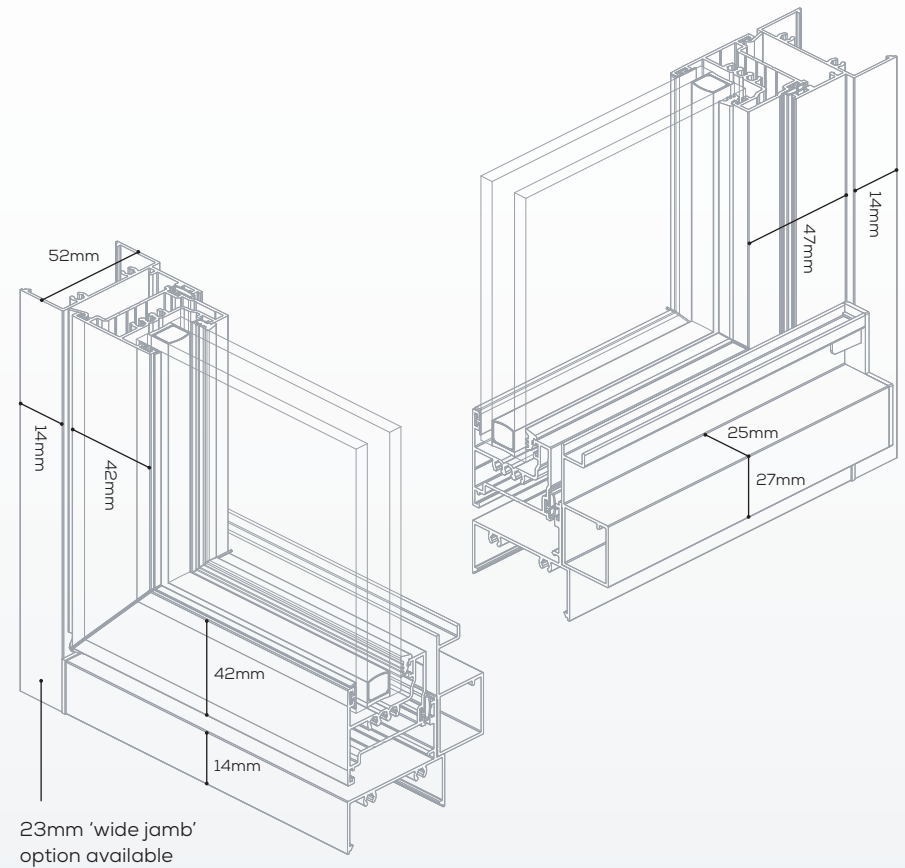

23mm 'wide jamb' option available

PROFILE DIMENSIONS

Note: Diagrams are not to scale. They are illustrations only, and may not accurately represent the product. Their purpose is to show the profile dimensions.

Single Glazed

Signature

Double Glazed

External View

Internal View

External View

Internal View

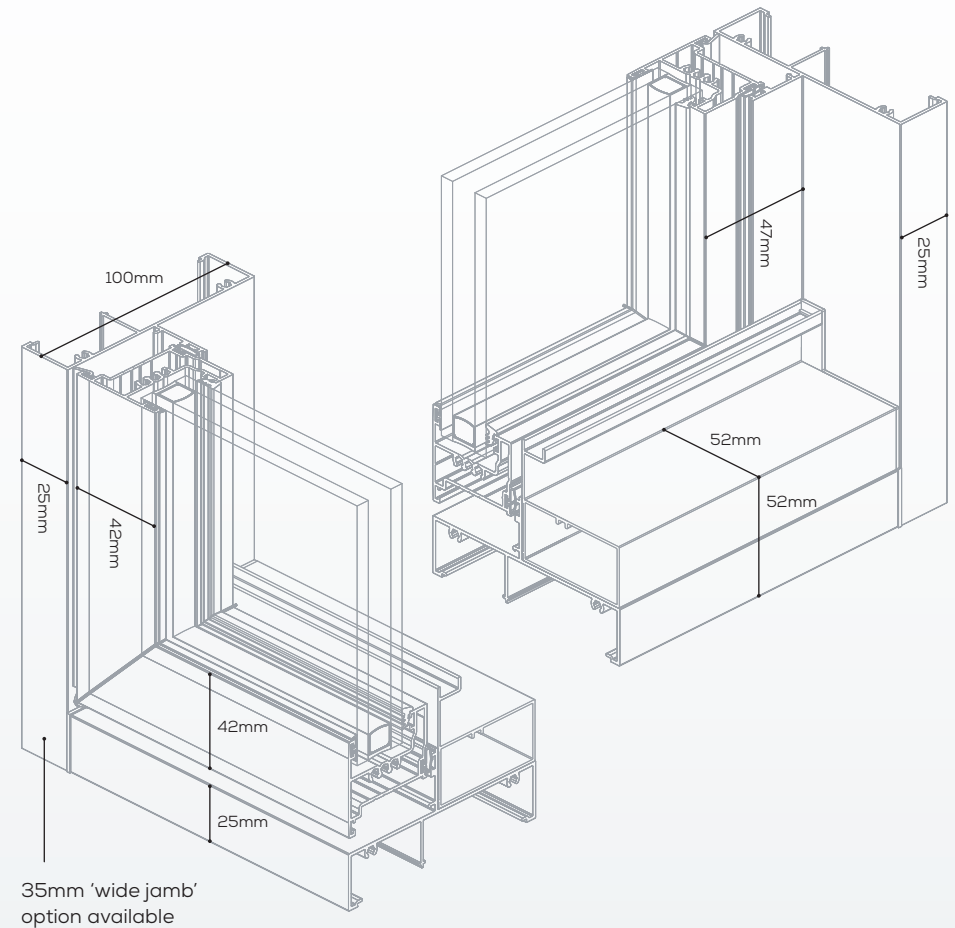
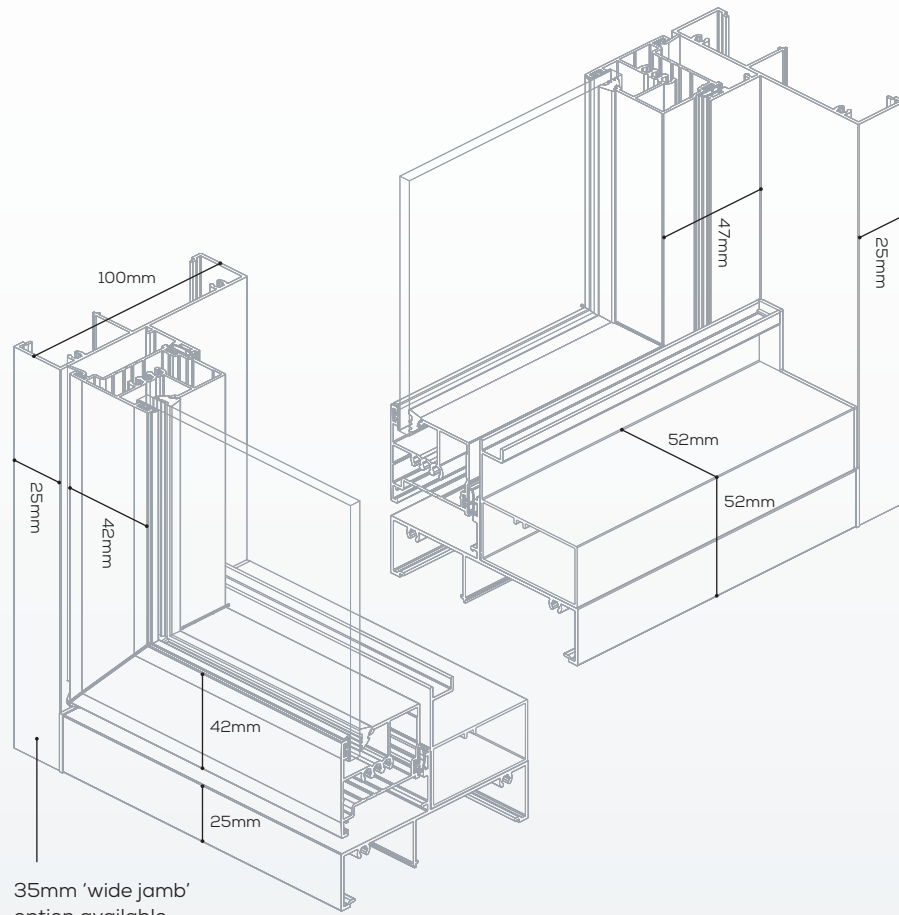

REVEAL SETBACKS

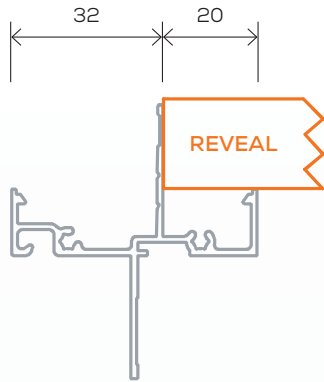

Essential Awning Window (52mm)

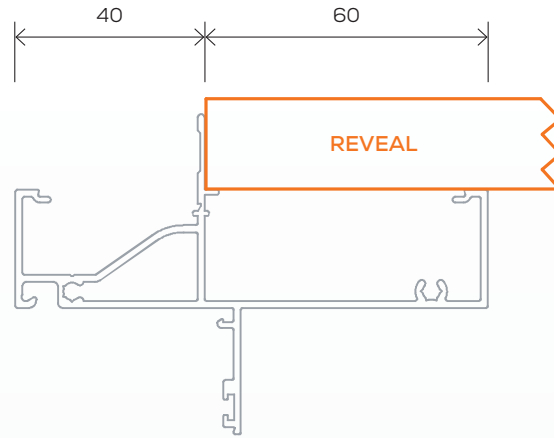

Signature Awning Window (100mm)
Commercial Awning Window (100mm)

SILL REBATES

Note: Diagrams are not to scale

Essential Awning Window 52

3546 FRAME EXT 52

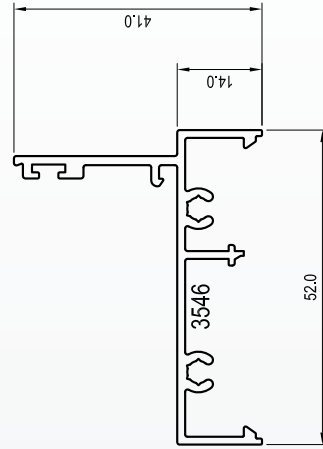

3546 FRAME EXT 52 WITH 2925 SUBSILL '35' 52

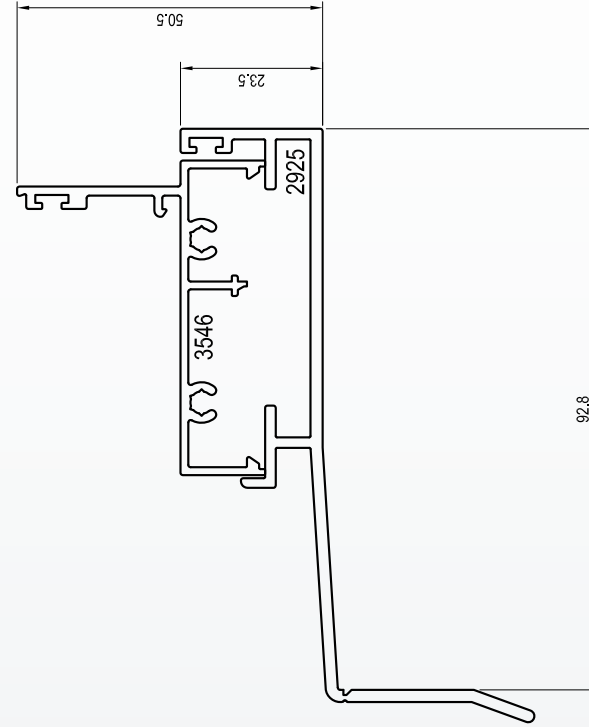

SILL REBATES

Note: Diagrams are not to scale

Signature Awning Window 100

3473 FRAME 100

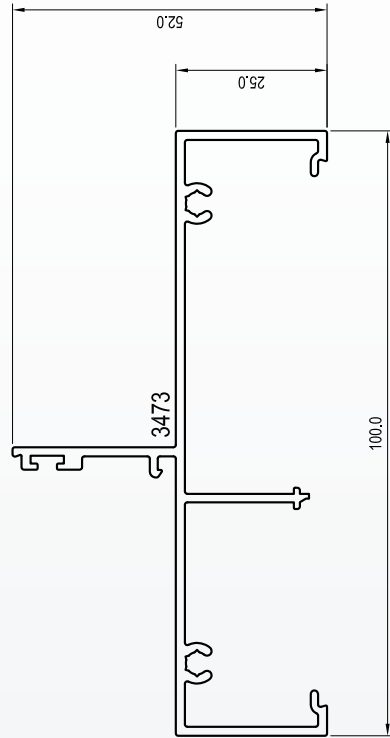

3473 FRAME 100 WITH 3353 SUBSILL '15' 100

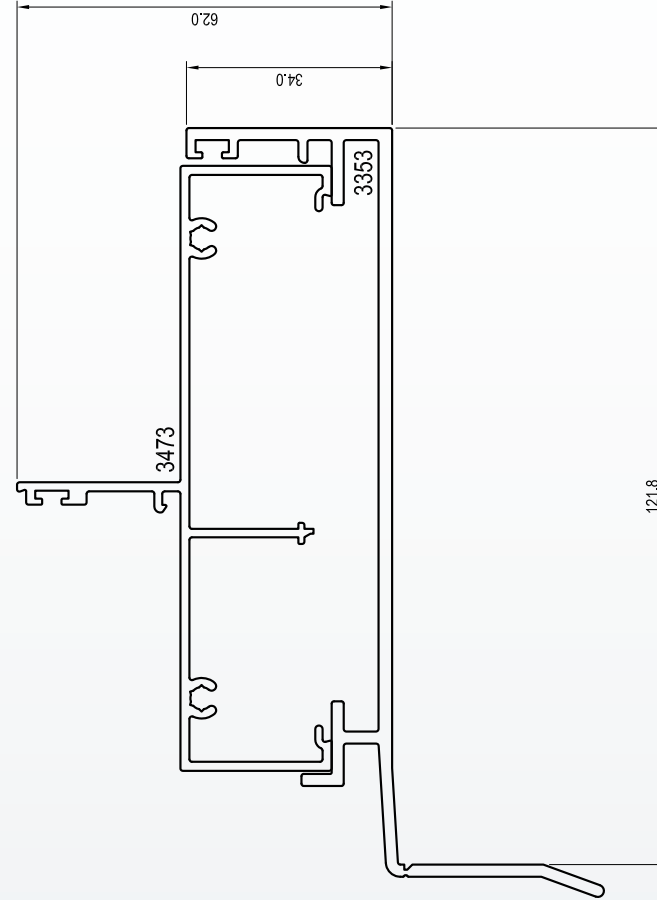

SILL REBATES

Note: Diagrams are not to scale

Signature Awning Window 100

3473 FRAME 100 WITH 3017 SUBSILL BAFFLED 100

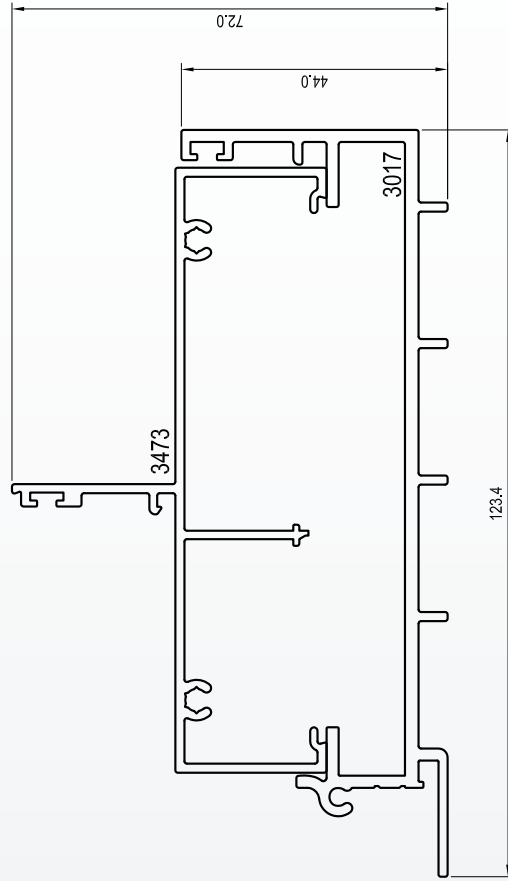

3473 FRAME 100 WITH 2876 SUBSILL '35' 100

