



BRADNAM'S

CORNER SLIDING DOORS

PRODUCT INFORMATION

Product performance is subject to regional variations, design requirements and building codes. Performance parameters are independent of each other.

Images are for illustration purposes only and may not accurately represent the product. Bradnam's Windows & Doors reserves the right to change, alter or delete any aspect of this product without notice.



PERFORMANCE PARAMETERS

CONFIGURATIONS

COLONIAL BAR OPTIONS

PROFILE DIMENSIONS

REVEAL SETBACKS

MEASURE SHEETS

SILL REBATES

TABLE OF CONTENTS

Performance Parameters	3
Configurations	4
Colonial Bar Options	5
Profile Dimensions	6
Reveal Setbacks	8
Measure Sheets	10
Sill Rebates	
Signature	26
Commercial	41

PERFORMANCE PARAMETERS

	Signature	Commercial
Frame sizes	100mm 166mm	100mm / 150mm 200mm / 250mm
Maximum door height	2700mm	3100mm
Maximum door width	6246mm	12000mm
Maximum panel width	1350mm	1800mm
Maximum panel weight	100kg	160kg
Maximum water rating	600Pa	650Pa
Maximum wind rating	4500Pa ULS	6000Pa ULS
Maximum glass thickness (single glazed)	12.76mm	10.76mm
Maximum glass thickness (double glazed)	20mm	28mm
Maximum acoustic rating	Rw44	Rw35
Maximum bushfire rating	BAL 40	BAL 40
Lowest U-value (single glazed)	4.2	4.5
Lowest U-value (double glazed)	2.7	3.1

Note: Performance figures are independent of each other and subject to conditions. Contact a Bradnam's Windows & Doors representative to discuss your specific project requirements.

CONFIGURATIONS

Designer

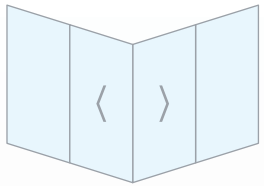

FS-SF

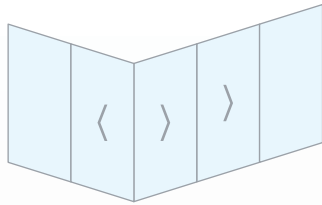

FS-SSF

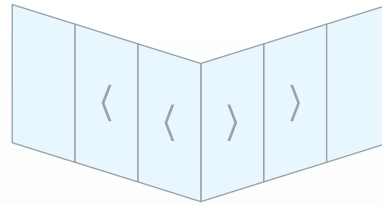

FSS-SSF

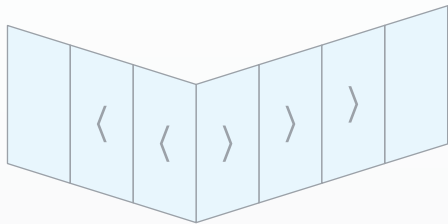

FSS-SSSF

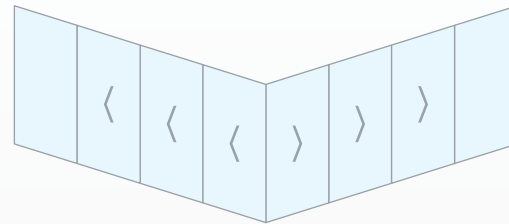

FSSS-SSSF

COLONIAL BAR OPTIONS

Design Options

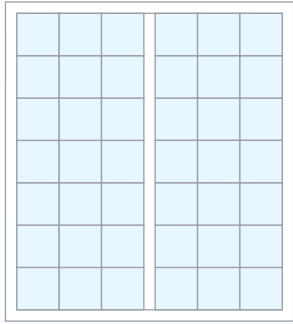

SF2118
Traditional Colonial

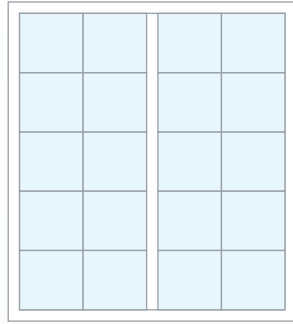

SF2118
Australian Colonial

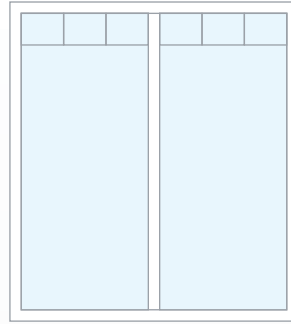

SF2118
Highlander

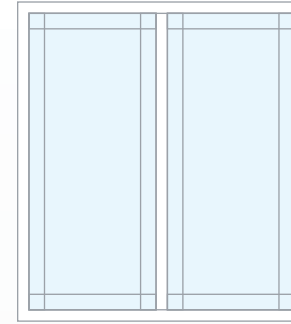

SF2118
Traditional Federation

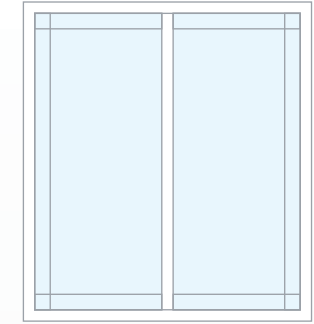

SF2118
Australian Federation

Types of Colonial Bar

Scale 5:1

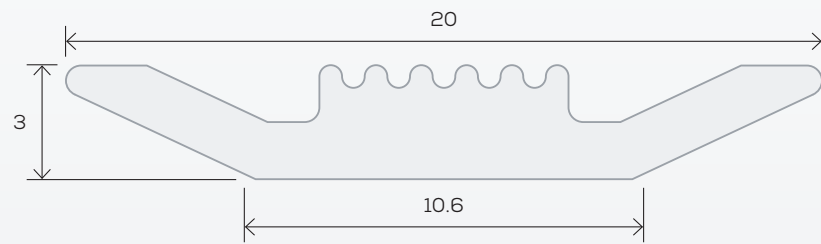

Raised



Flat

PROFILE DIMENSIONS

Note: Diagrams are not to scale. They are illustrations only, and may not accurately represent the product. Their purpose is to show the profile dimensions.

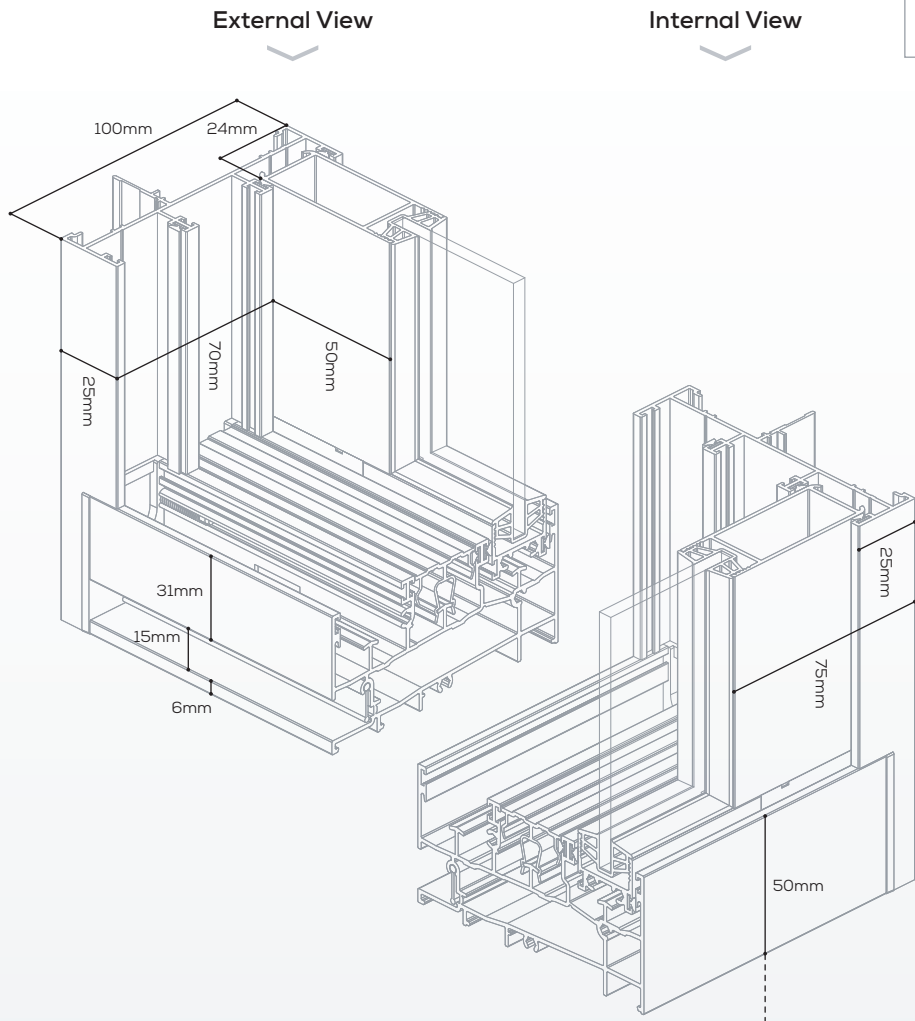

Signature Sliding Door (100mm)

80mm '600 pascal sill' available
17mm and 32mm 'low profile sill' available

Signature

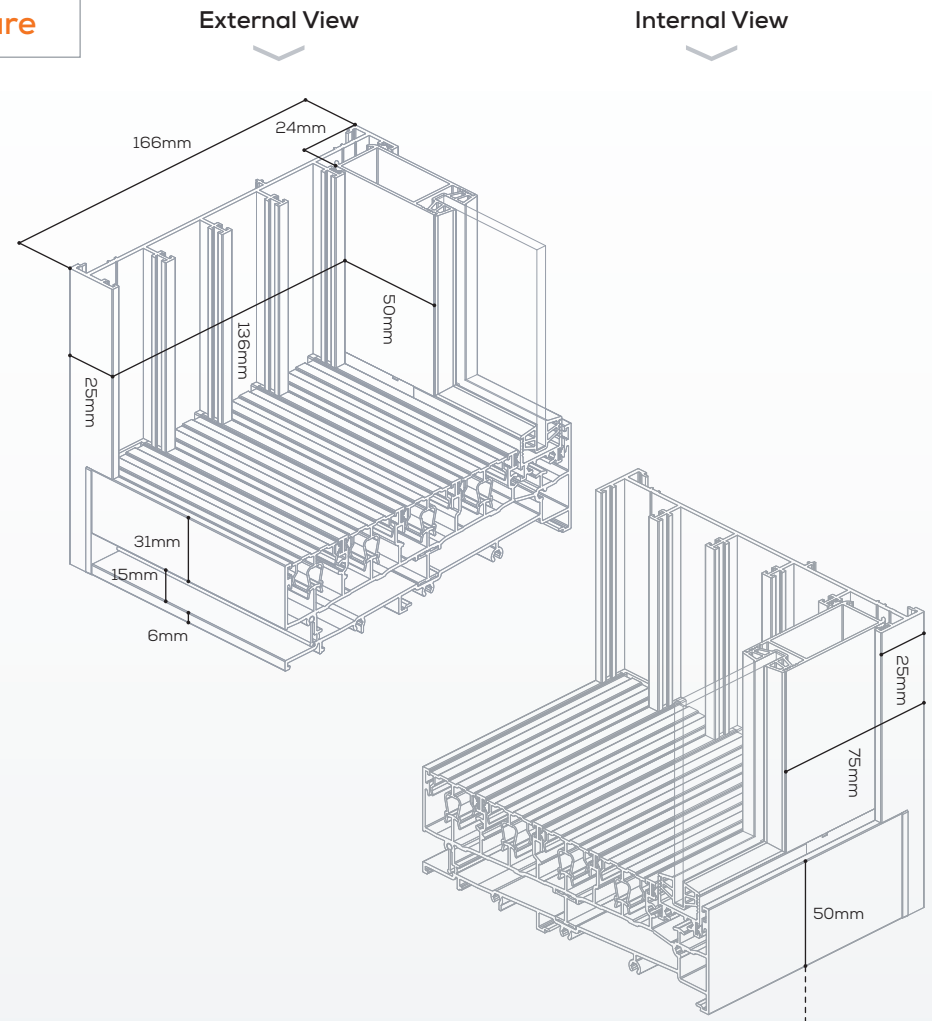

Signature Sliding Door (166mm)

80mm '600 pascal sill' available
17mm and 32mm 'low profile sill' available

PROFILE DIMENSIONS

Note: Diagrams are not to scale. They are illustrations only, and may not accurately represent the product. Their purpose is to show the profile dimensions.

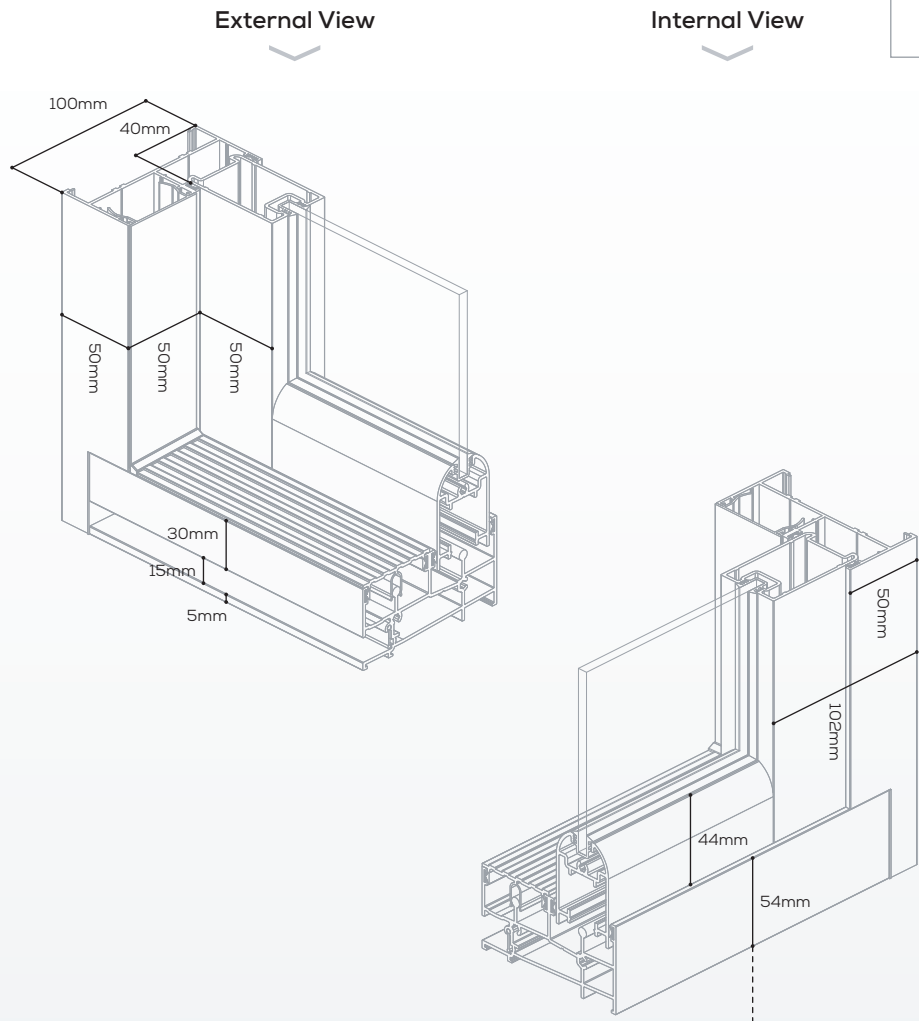

Commercial Sliding Door (100mm)

84mm '600 pascal sill' available
19mm 'low profile sill' available

Commercial

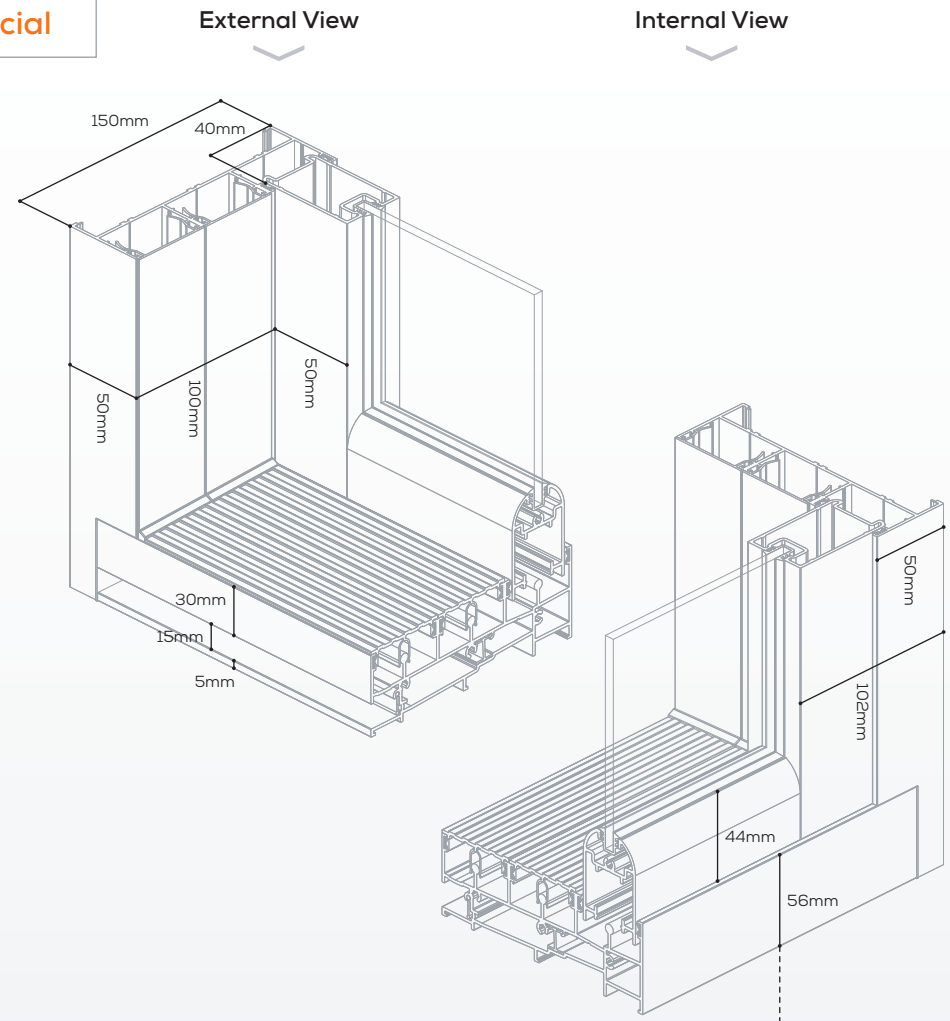

Commercial Sliding Door (150mm)

86mm '600 pascal sill' available
21mm 'low profile sill' available

REVEAL SETBACKS

Note: Diagrams are not to scale

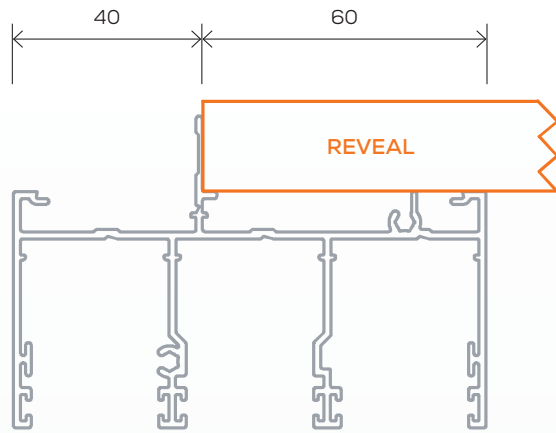

Signature Corner Sliding Door (100mm)

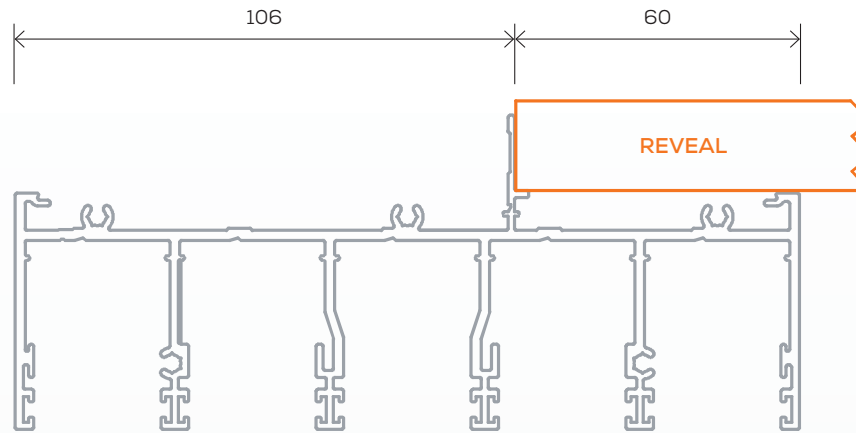

Signature Corner Sliding Door (166mm)

REVEAL SETBACKS

Note: Diagrams are not to scale

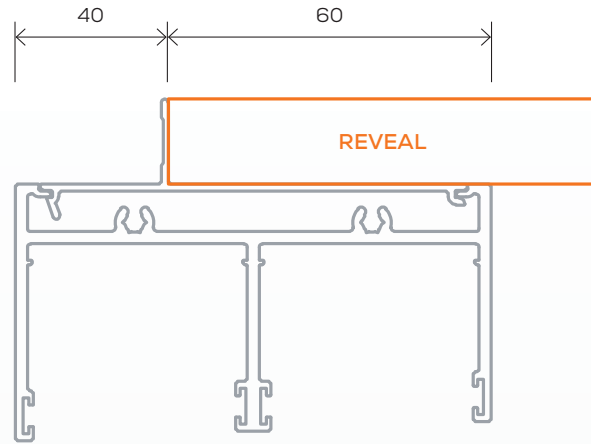

Commercial Corner Sliding Door (100mm)

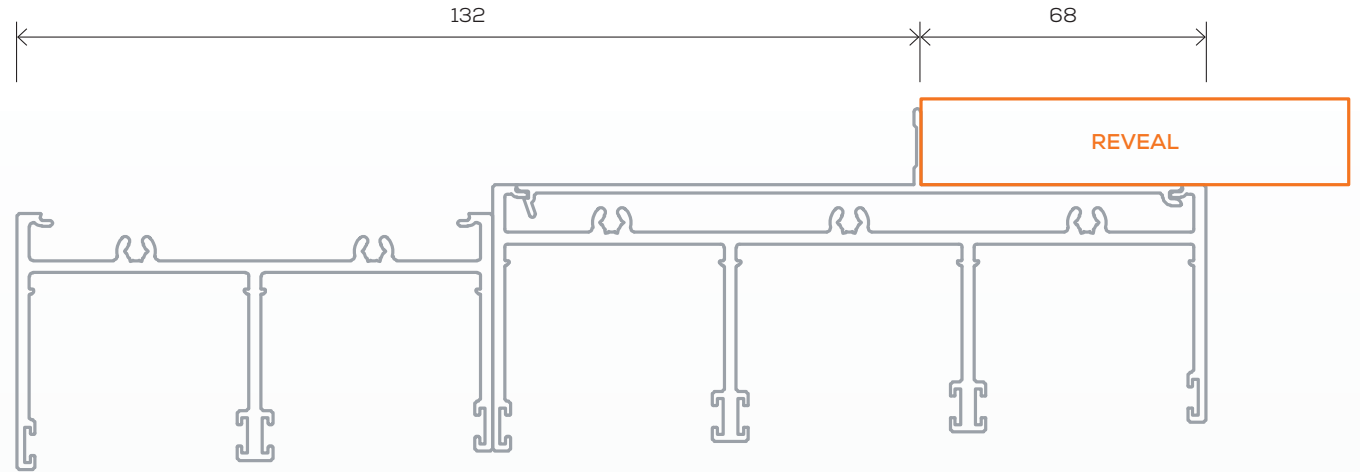

Commercial Corner Sliding Door (200mm)

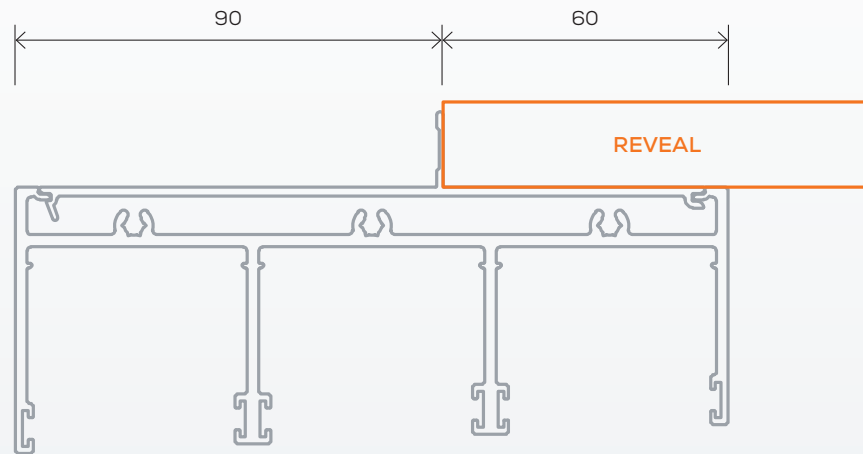

Commercial Corner Sliding Door (150mm)

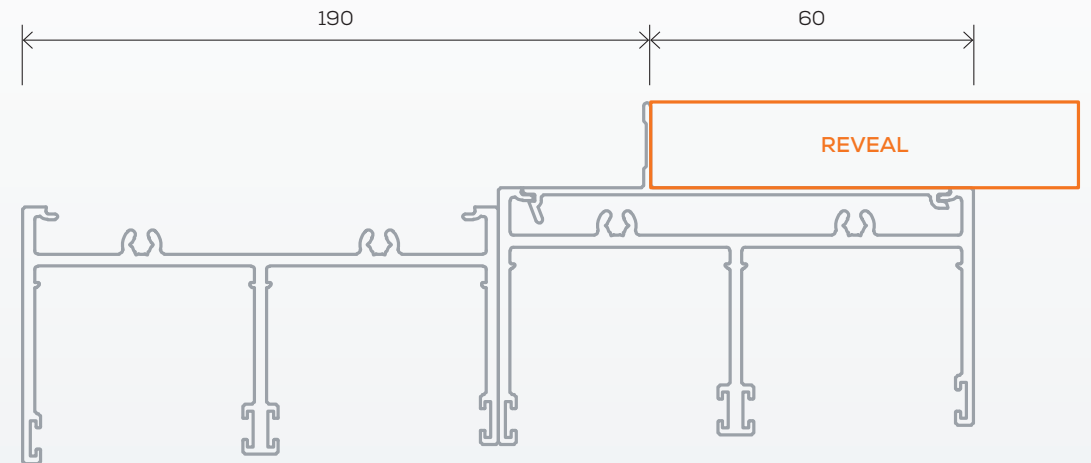

Commercial Corner Sliding Door (250mm)

MEASURE SHEETS

Note: Diagrams are not to scale

signature sliding door 100mm - external 90° corner

- 81 mm reveals: frame width = opening width + 86
- 98mm reveals: frame width = opening width + 103
- 100mm reveals: frame width = opening width + 105
- 116mm reveals: frame width = opening width + 121
- 125mm reveals: frame width = opening width + 130
- 138mm reveals: frame width = opening width + 143

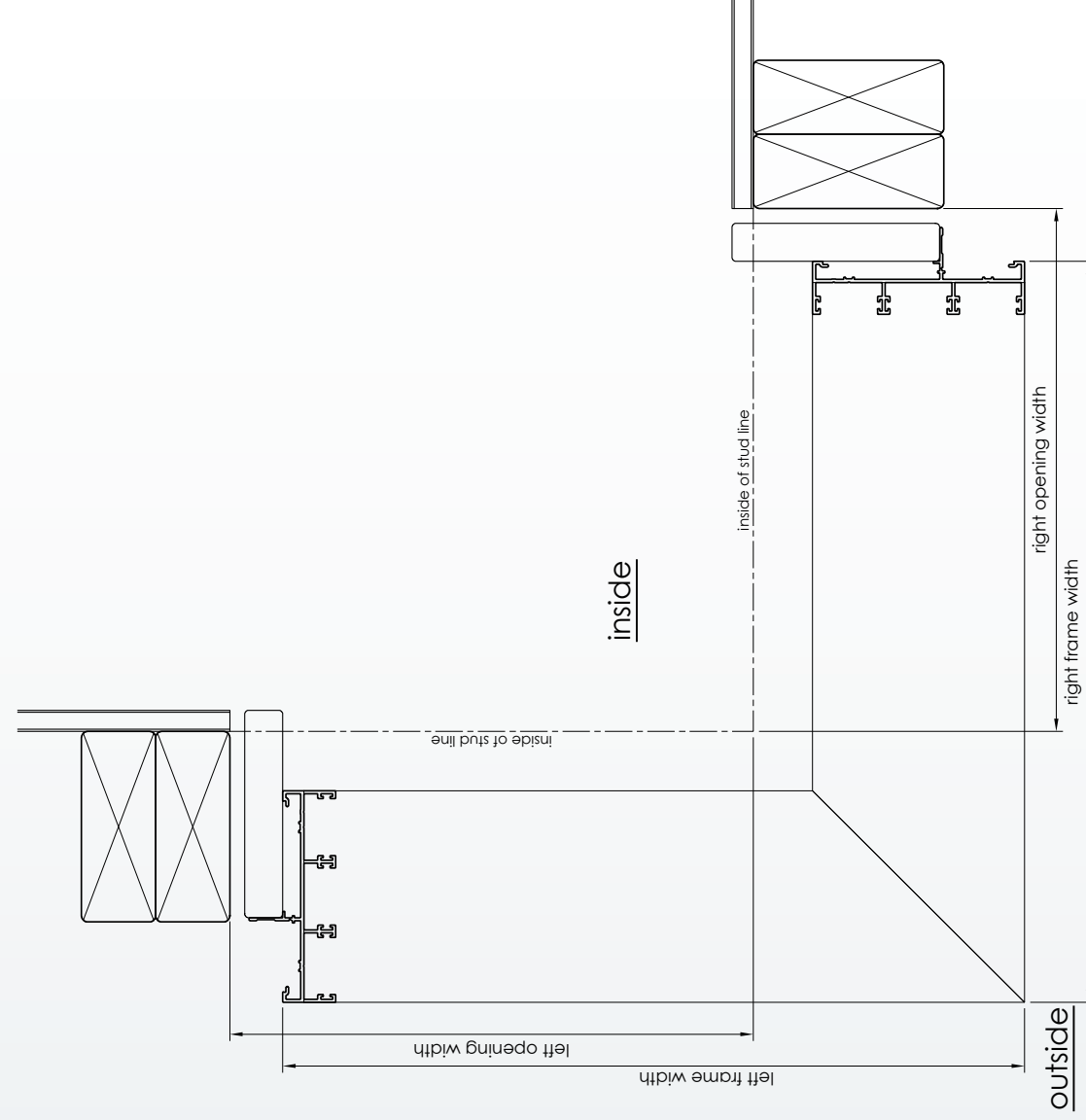

MEASURE SHEETS

Note: Diagrams are not to scale

signature sliding door 100mm - internal 90° corner

- 81mm reveals: frame width = opening width – 136
- 98mm reveals: frame width = opening width – 153
- 100mm reveals: frame width = opening width – 155
- 116mm reveals: frame width = opening width – 171
- 125mm reveals: frame width = opening width – 180
- 138mm reveals: frame width = opening width – 193

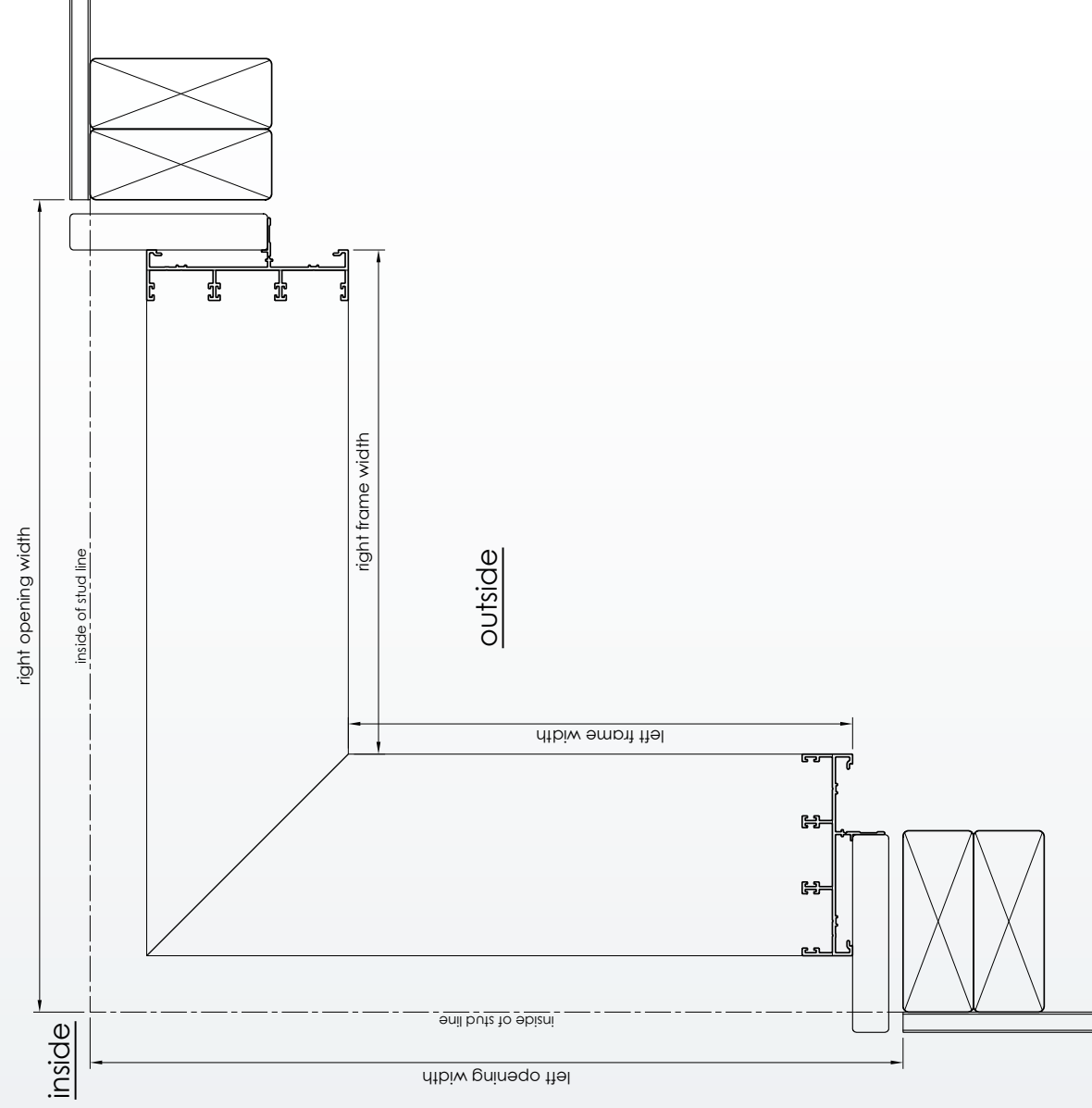

MEASURE SHEETS

Note: Diagrams are not to scale

signature sliding door 100mm - external 90° corner slab & block set-out

note: measurement taken from inside of blockwork.

'clearance' refers to gap between jamb & blockwork,

'offset' refers to distance from inside of block to the inside of frame.

left frame width = (left opening width + 100 + offset) - clearance

right frame width = (right opening width + 100 + offset) - clearance

frame width = left frame width + right frame width

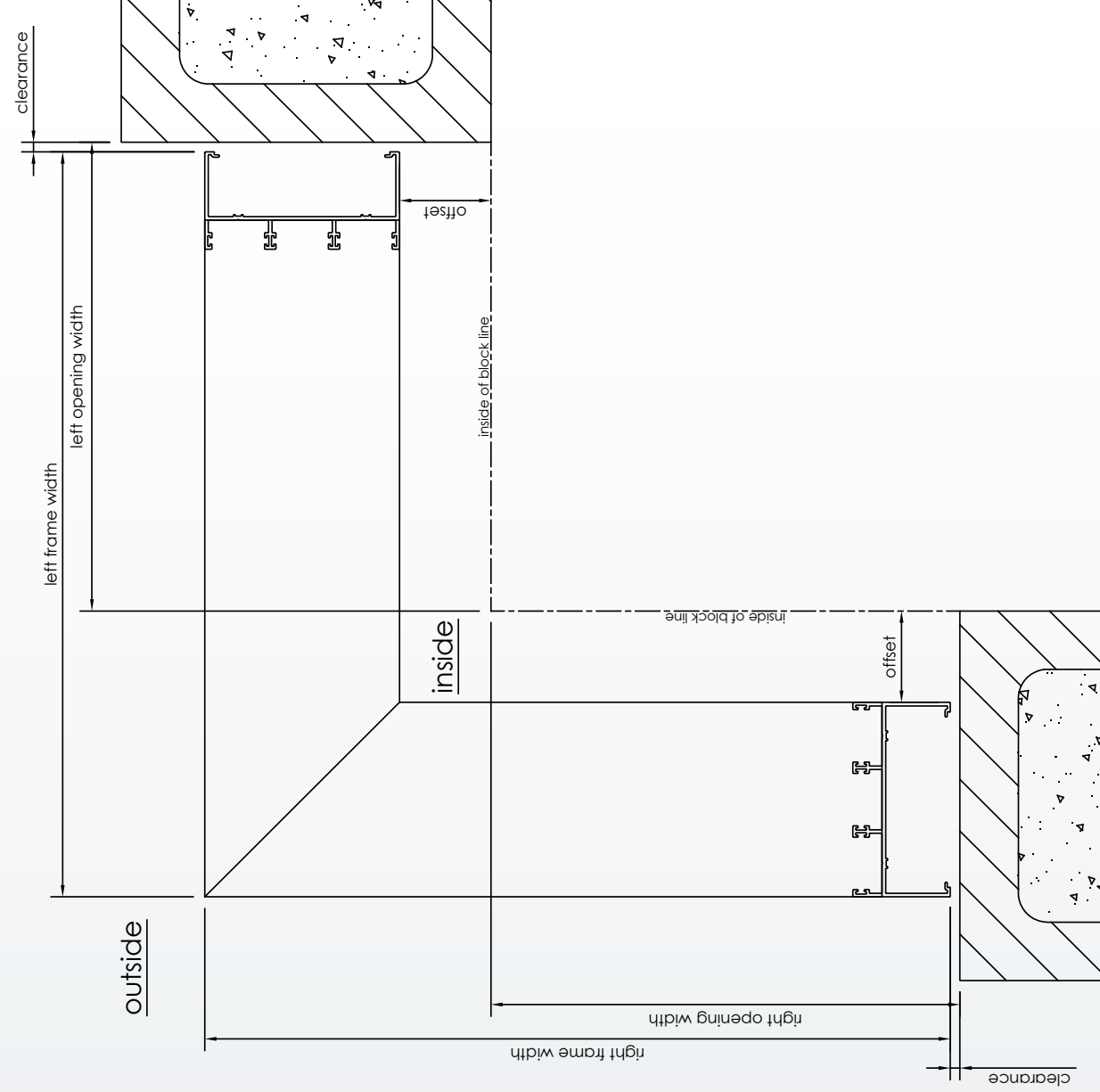

MEASURE SHEETS

Note: Diagrams are not to scale

signature sliding door 100mm - internal 90° corner slab & block set-out

note: measurement taken from inside of blockwork.
 'clearance' refers to gap between jamb & blockwork,
 'offset' refers to distance from inside of block to the inside of frame.

left frame width = left opening width - (100 + offset + clearance)
 right frame width = right opening width - (100 + offset + clearance)
 frame width = left frame width + right frame width

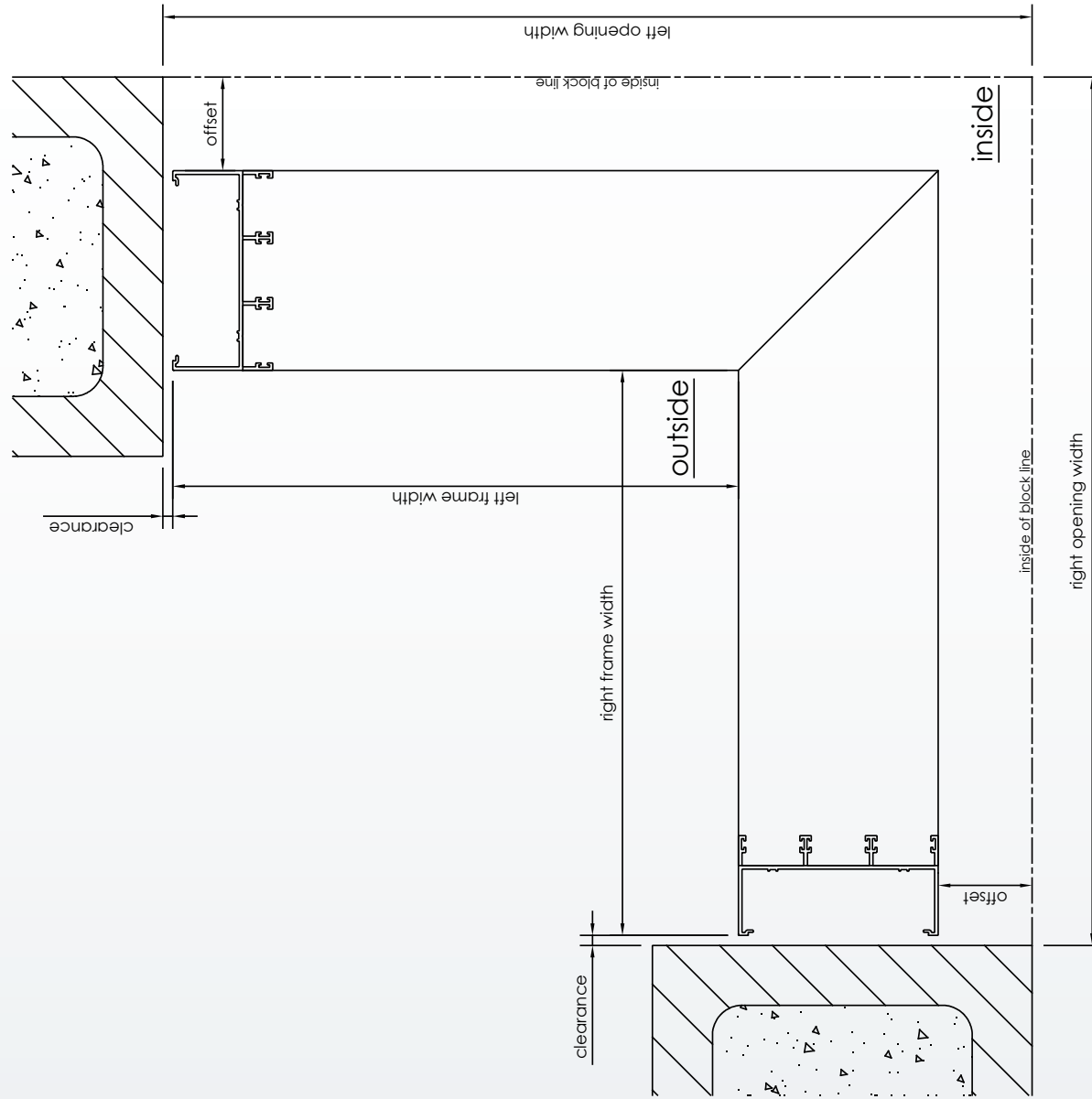

MEASURE SHEETS

Note: Diagrams are not to scale

signature sliding door 166mm - external 90° corner

- 81mm reveals: frame width = opening width + 152
- 98mm reveals: frame width = opening width + 169
- 100mm reveals: frame width = opening width + 171
- 116mm reveals: frame width = opening width + 187
- 125mm reveals: frame width = opening width + 196
- 138mm reveals: frame width = opening width + 209

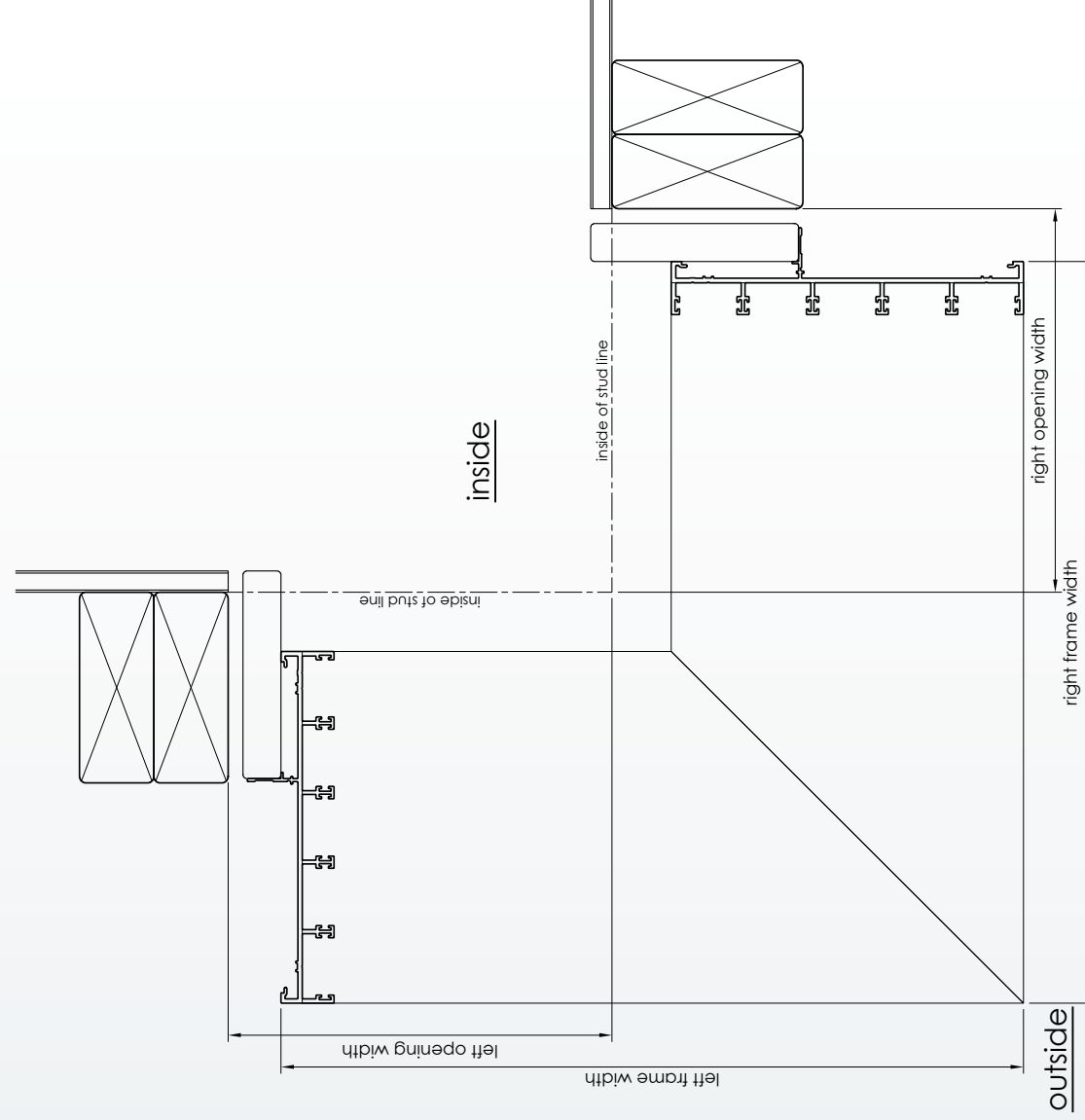

MEASURE SHEETS

Note: Diagrams are not to scale

signature sliding door 166mm - internal 90° corner

- 81mm reveals: frame width = opening width – 202
- 98mm reveals: frame width = opening width – 219
- 100mm reveals: frame width = opening width – 221
- 116mm reveals: frame width = opening width – 237
- 125mm reveals: frame width = opening width – 246
- 138mm reveals: frame width = opening width – 259

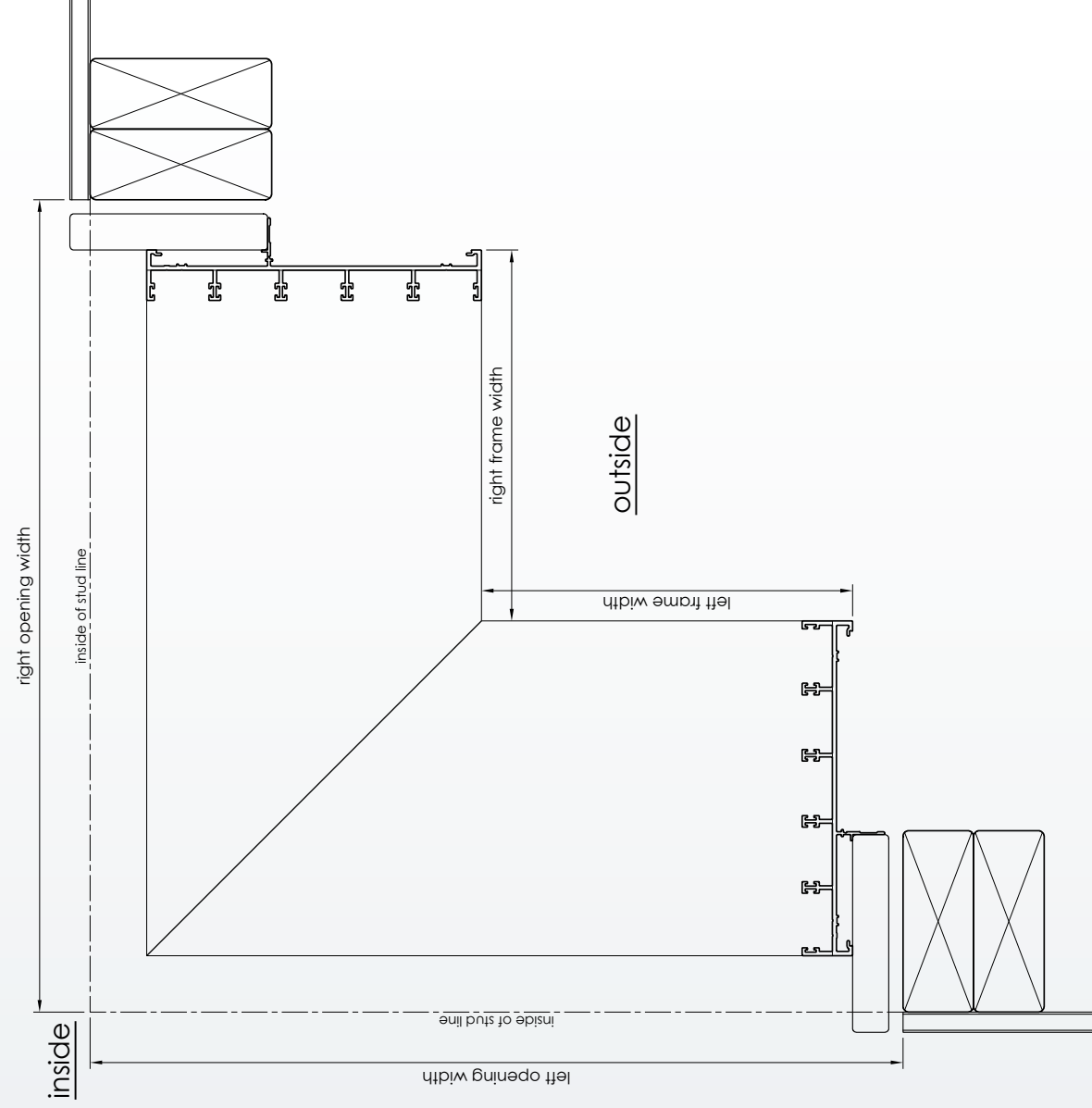

MEASURE SHEETS

Note: Diagrams are not to scale

signature sliding door 166mm - external 90° corner slab & block set-out

note: measurement taken from inside of blockwork.
 'clearance' refers to gap between jamb & blockwork,
 'offset' refers to distance from inside of block to the inside of frame.

left frame width = (left opening width + 166 + offset) - clearance
 right frame width = (right opening width + 166 + offset) - clearance
 frame width = left frame width + right frame width

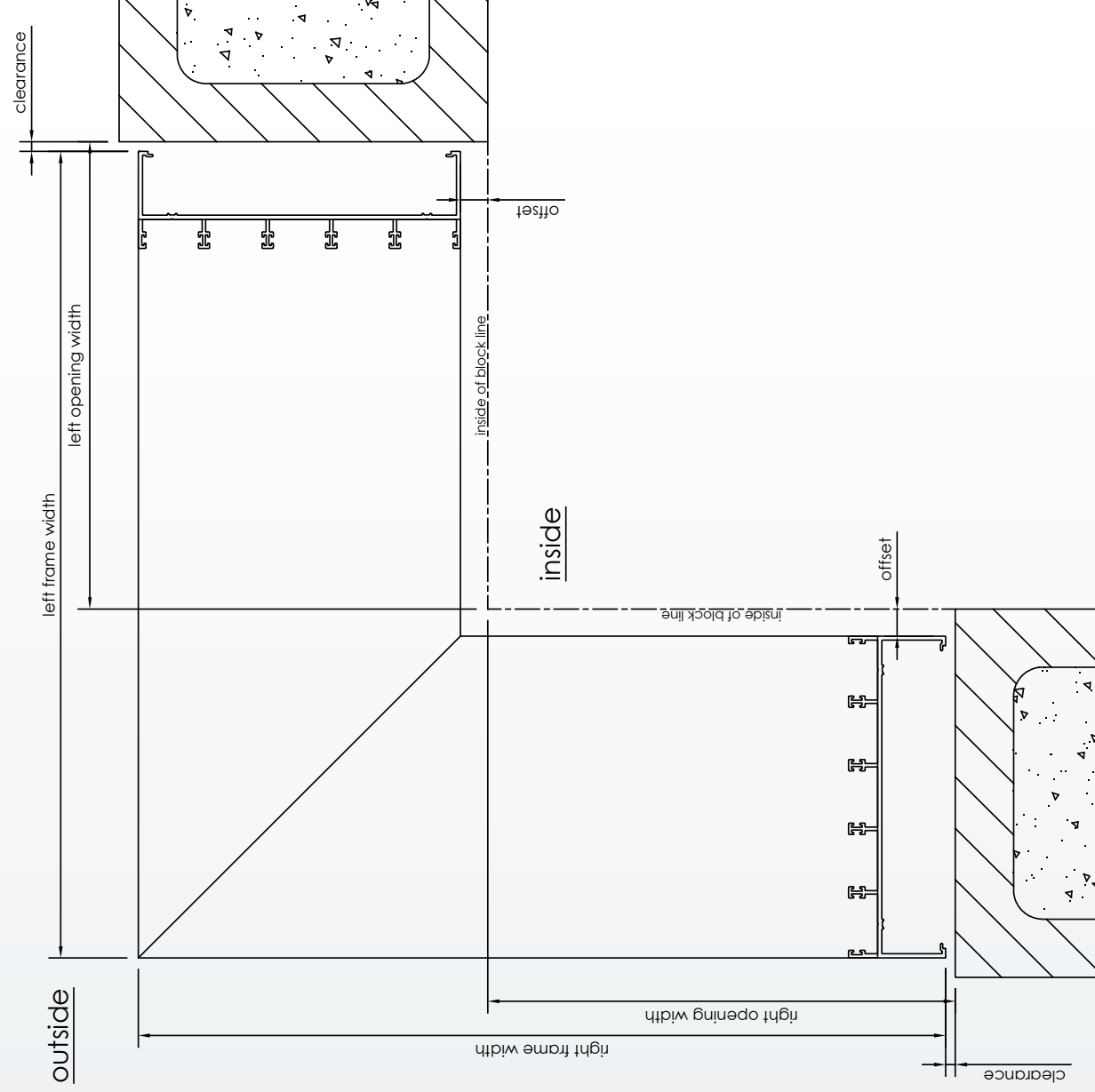

MEASURE SHEETS

Note: Diagrams are not to scale

signature sliding door 166mm - internal 90° corner slab & block set-out

note: measurement taken from inside of blockwork.

'clearance' refers to gap between jamb & blockwork,

'offset' refers to distance from inside of block to the inside of frame.

left frame width = left opening width - (166 + offset + clearance)

right frame width = right opening width - (166 + offset + clearance)

frame width = left frame width + right frame width

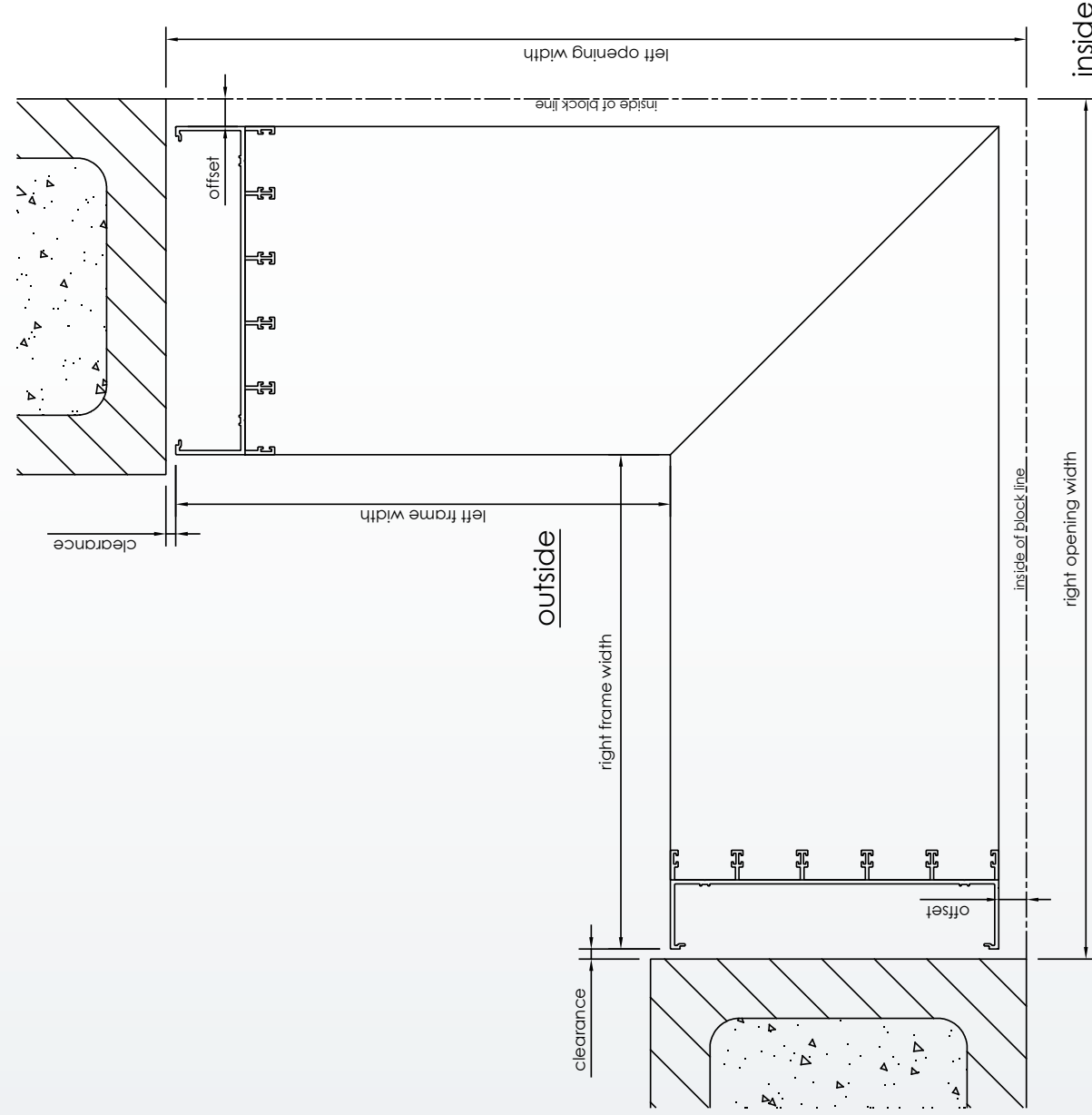

MEASURE SHEETS

Note: Diagrams are not to scale

commercial sliding door 100mm - external 90° corner slab & block set-out

note: measurement taken from inside of blockwork.

'clearance' refers to gap between jamb & blockwork,

'offset' refers to distance from inside of block to the inside of frame.

left frame width = (left opening width + 100 + offset) - clearance

right frame width = (right opening width + 100 + offset) - clearance

frame width = left frame width + right frame width

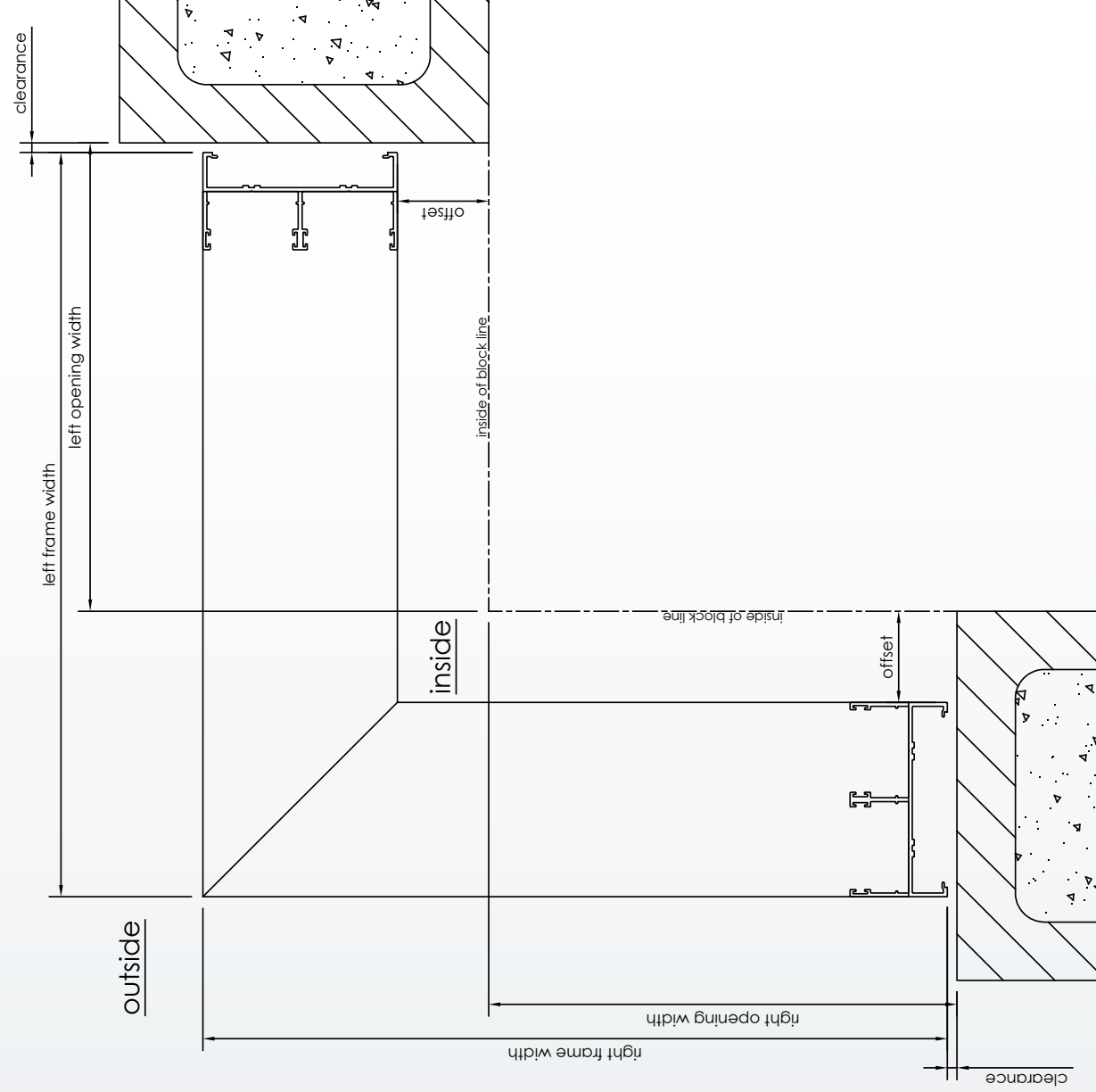

MEASURE SHEETS

Note: Diagrams are not to scale

commercial sliding door 100mm - external 90° corner

- 81 mm reveals: frame width = opening width + 86
- 98mm reveals: frame width = opening width + 103
- 100mm reveals: frame width = opening width + 105
- 116mm reveals: frame width = opening width + 121
- 125mm reveals: frame width = opening width + 130
- 138mm reveals: frame width = opening width + 143

calculations suit 3982 adaptor fin 100-40 V2

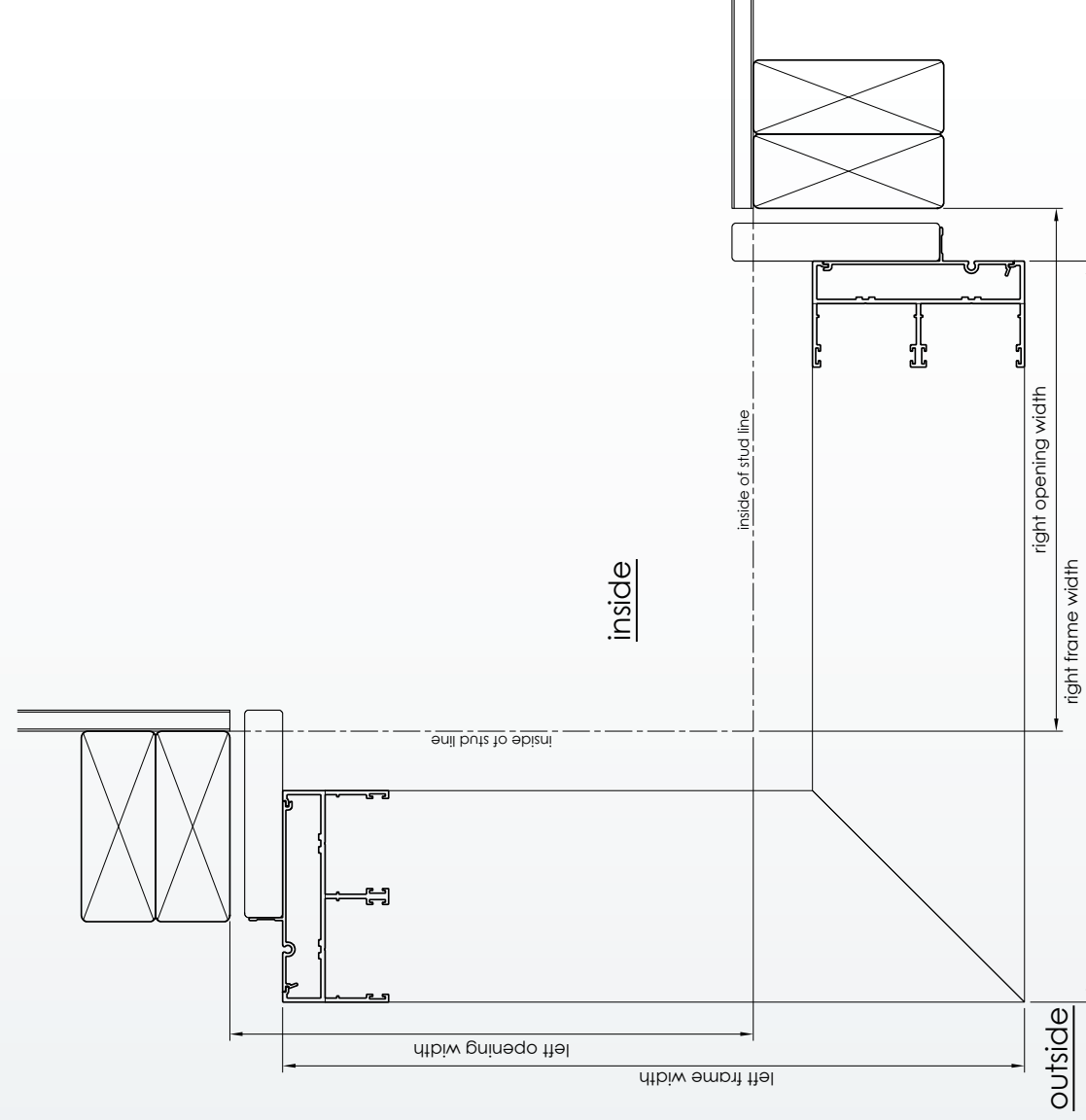

MEASURE SHEETS

Note: Diagrams are not to scale

commercial sliding door 100mm - internal 90° corner slab & block set-out

note: measurement taken from inside of blockwork.

'clearance' refers to gap between jamb & blockwork,

'offset' refers to distance from inside of block to the inside of frame.

left frame width = left opening width - (100 + offset + clearance)

right frame width = right opening width - (100 + offset + clearance)

frame width = left frame width + right frame width

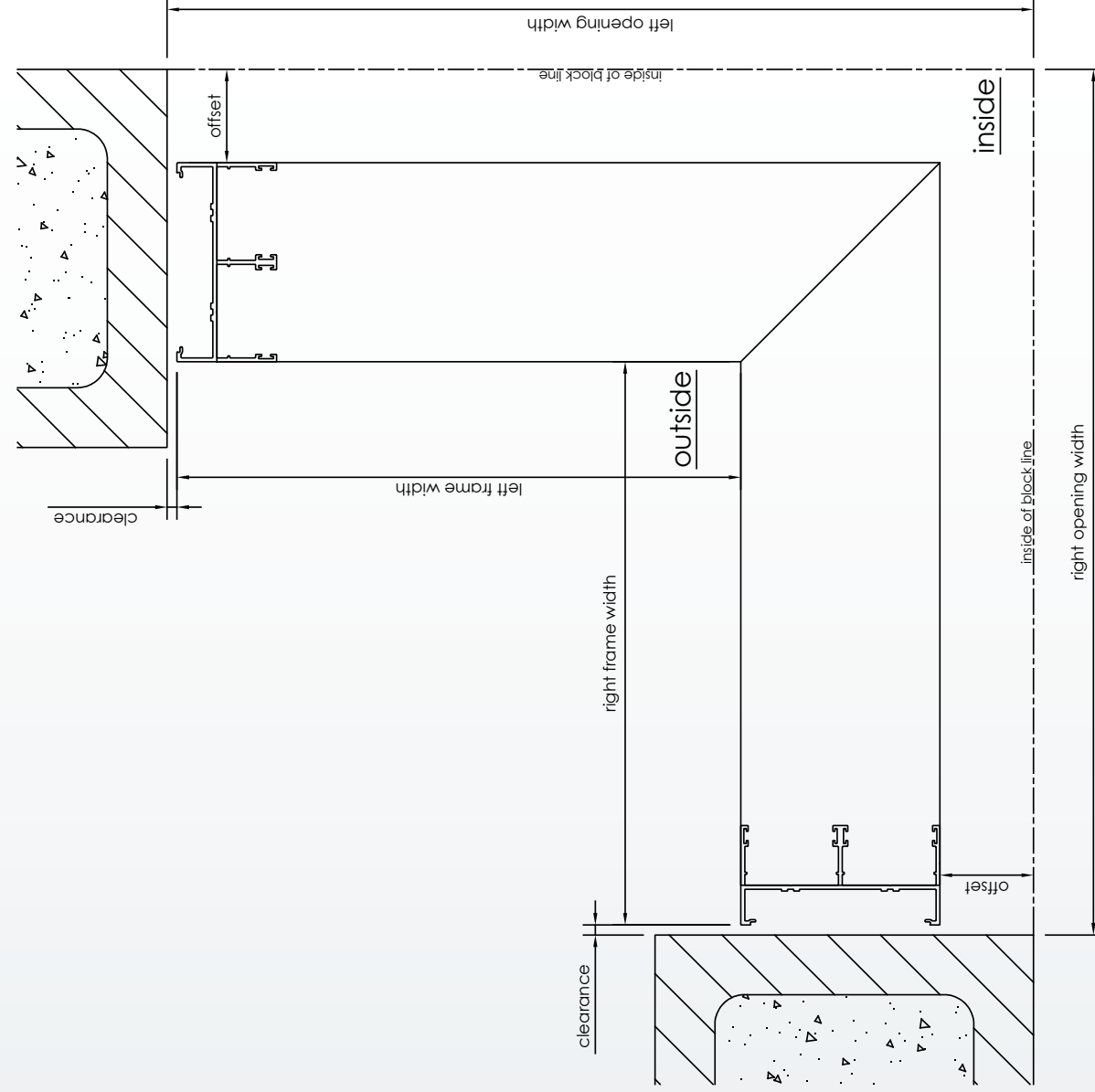

MEASURE SHEETS

Note: Diagrams are not to scale

commercial sliding door 100mm - internal 90° corner

- 81mm reveals: frame width = opening width – 136
 - 98mm reveals: frame width = opening width – 153
 - 100mm reveals: frame width = opening width – 155
 - 116mm reveals: frame width = opening width – 171
 - 125mm reveals: frame width = opening width – 180
 - 138mm reveals: frame width = opening width – 193
- calculations suit 3982 adaptor fin 100-40 V2

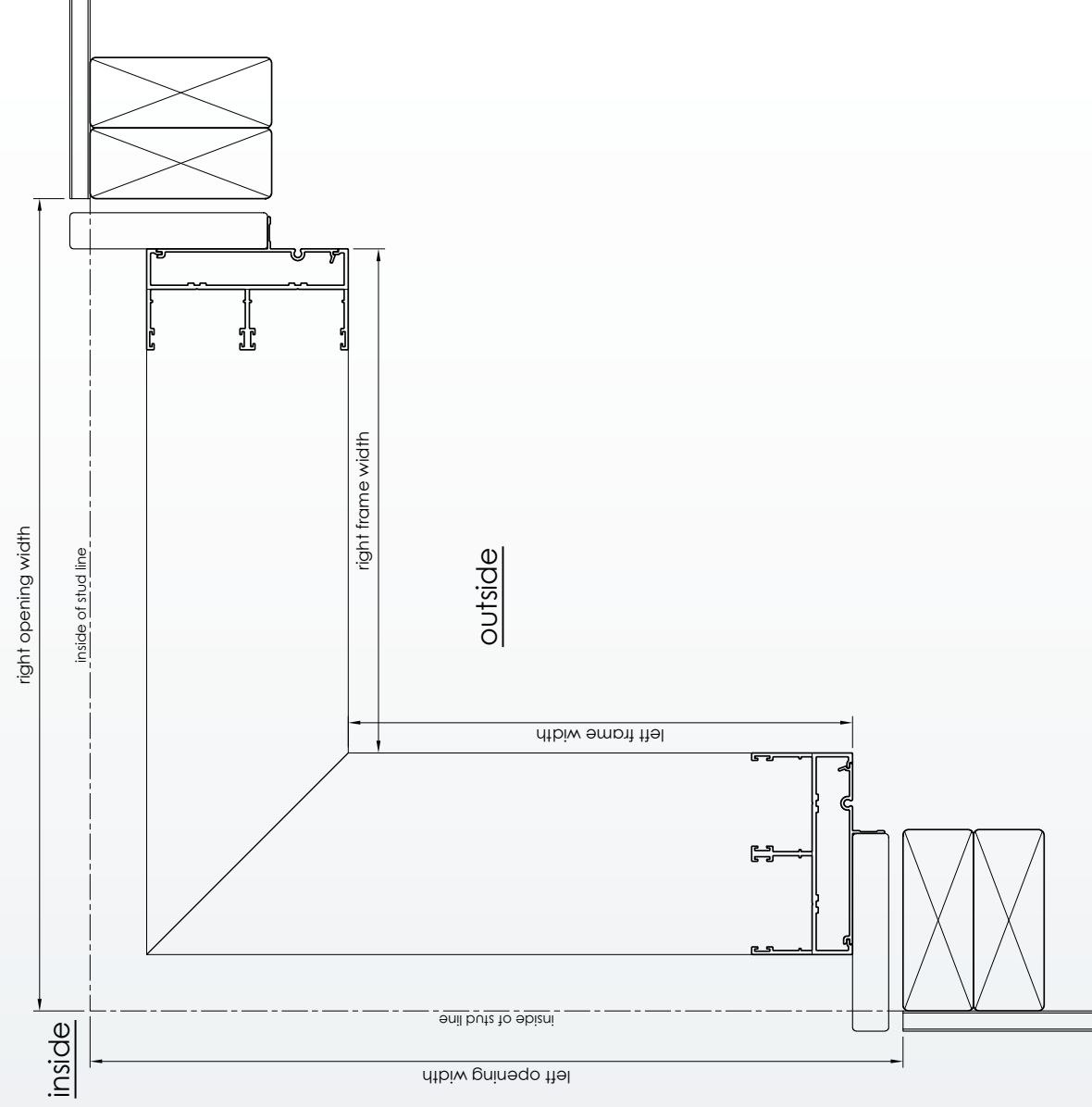

MEASURE SHEETS

Note: Diagrams are not to scale

commercial sliding door 150mm - external 90° corner slab & block set-out

note: measurement taken from inside of blockwork.

'clearance' refers to gap between jamb & blockwork,

'offset' refers to distance from inside of block to the inside of frame.

left frame width = (left opening width + 150 + offset) - clearance

right frame width = (right opening width + 150 + offset) - clearance

frame width = left frame width + right frame width

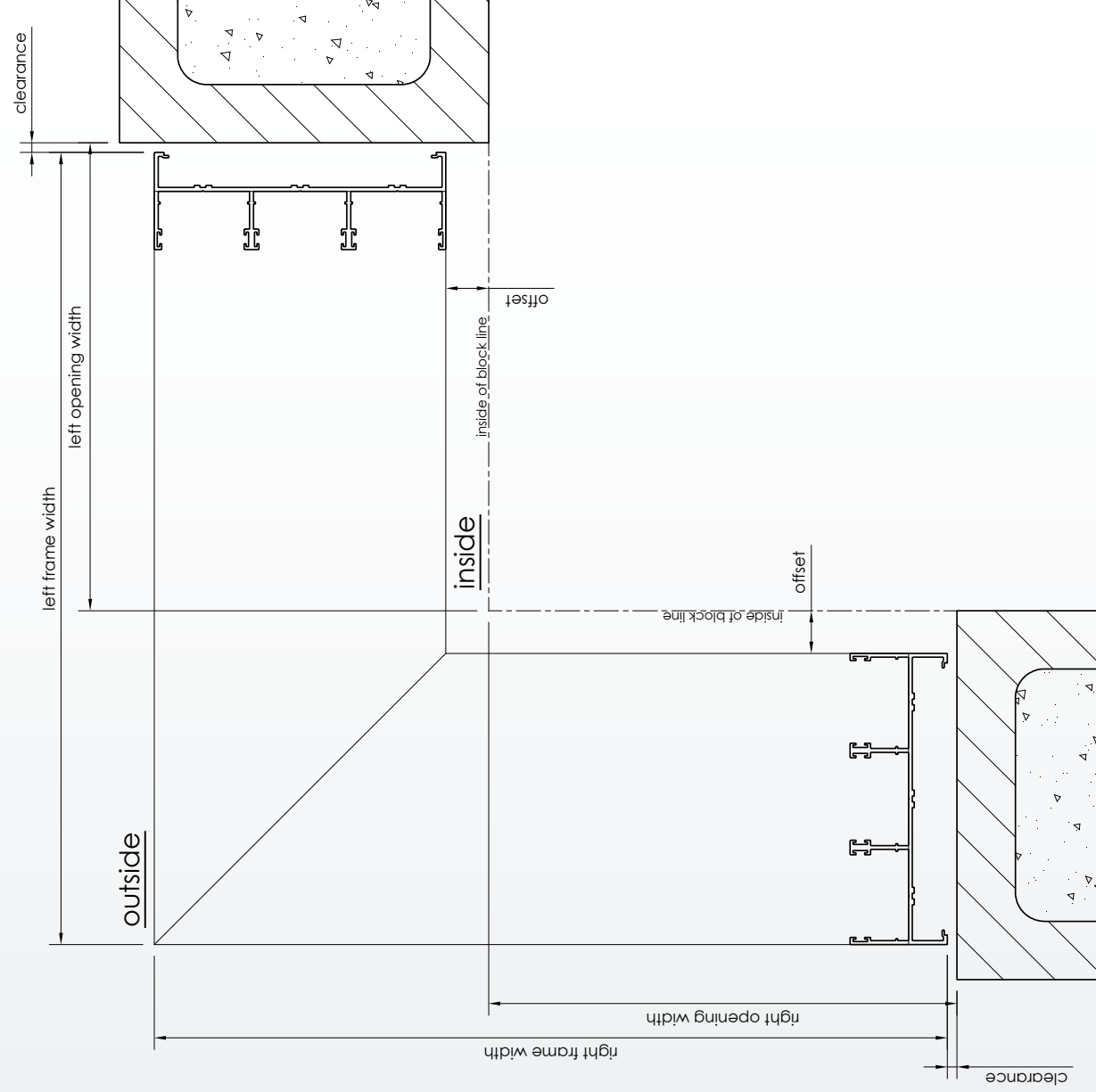

MEASURE SHEETS

Note: Diagrams are not to scale

commercial sliding door 150mm - external 90° corner

- 81mm reveals: frame width = opening width + 136
- 98mm reveals: frame width = opening width + 153
- 100mm reveals: frame width = opening width + 155
- 116mm reveals: frame width = opening width + 171
- 125mm reveals: frame width = opening width + 180
- 138mm reveals: frame width = opening width + 193

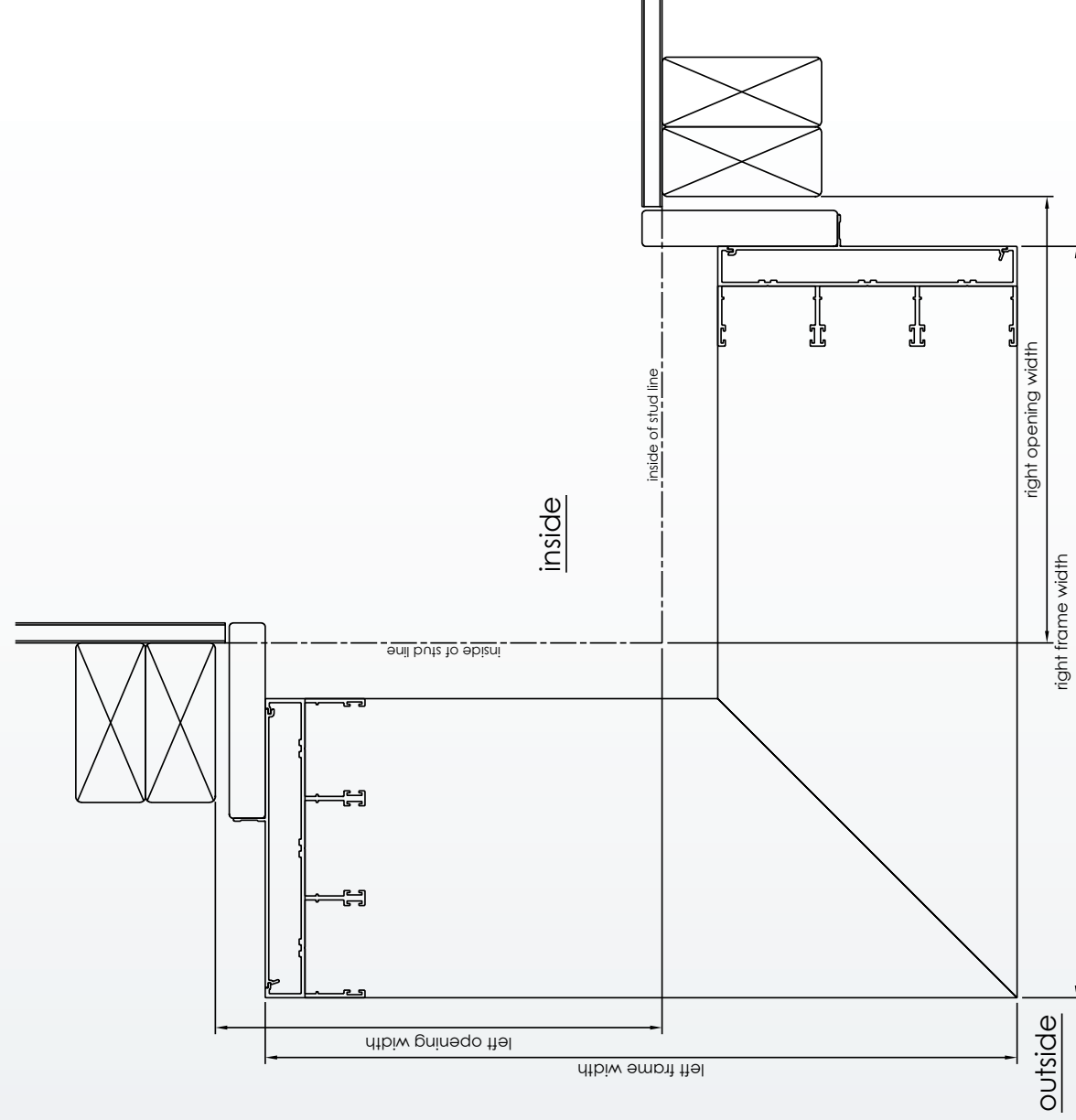

MEASURE SHEETS

Note: Diagrams are not to scale

commercial sliding door 150mm - internal 90° corner slab & block set-out

note: measurement taken from inside of blockwork.
 'clearance' refers to gap between jamb & blockwork,
 'offset' refers to distance from inside of block to the inside of frame.

left frame width = left opening width - (150 + offset + clearance)
 right frame width = right opening width - (150 + offset + clearance)
 frame width = left frame width + right frame width

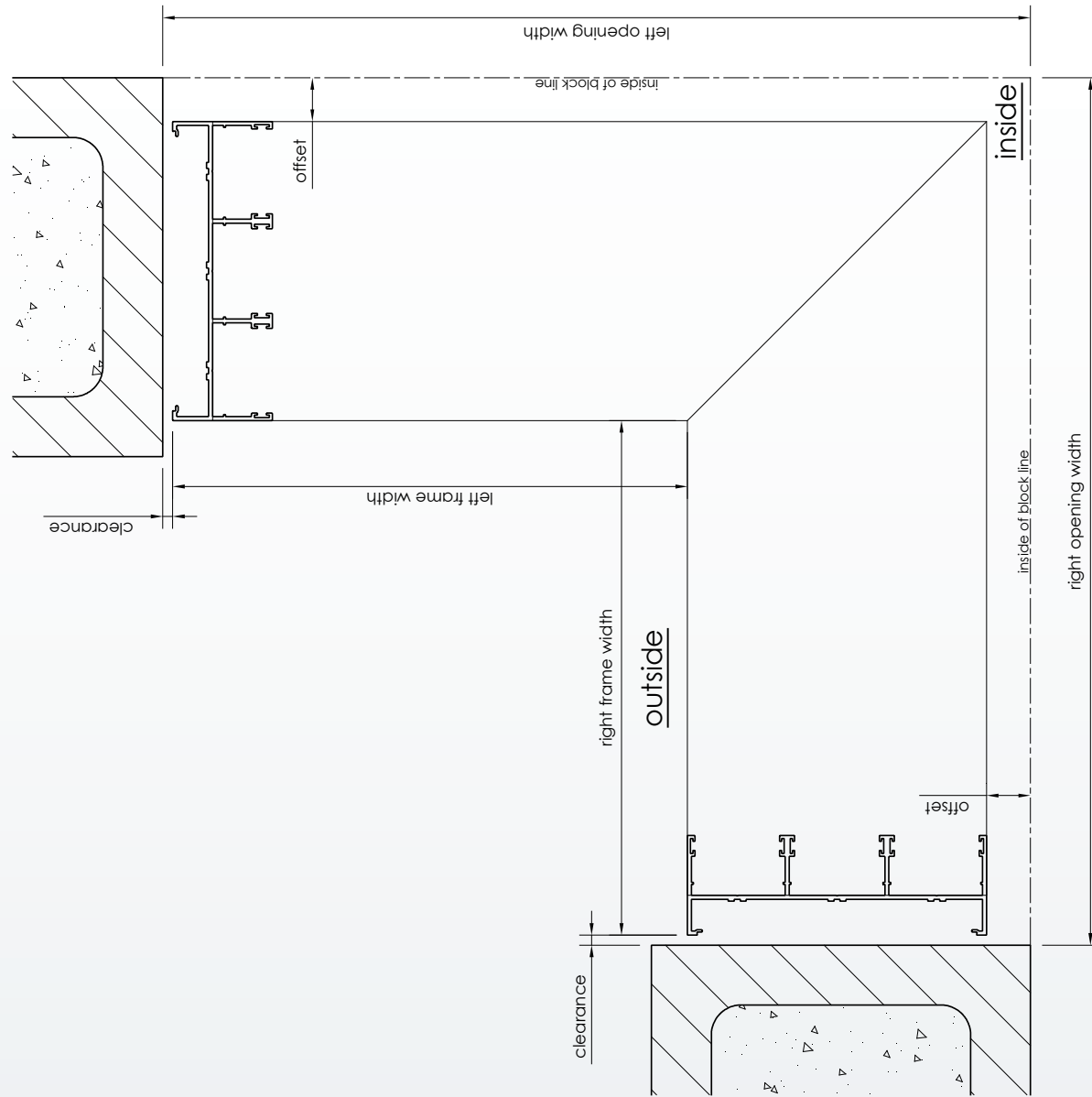

MEASURE SHEETS

Note: Diagrams are not to scale

commercial sliding door 150mm - internal 90° corner

- 81mm reveals: frame width = opening width – 186
- 98mm reveals: frame width = opening width – 203
- 100mm reveals: frame width = opening width – 205
- 116mm reveals: frame width = opening width – 221
- 125mm reveals: frame width = opening width – 230
- 138mm reveals: frame width = opening width – 243

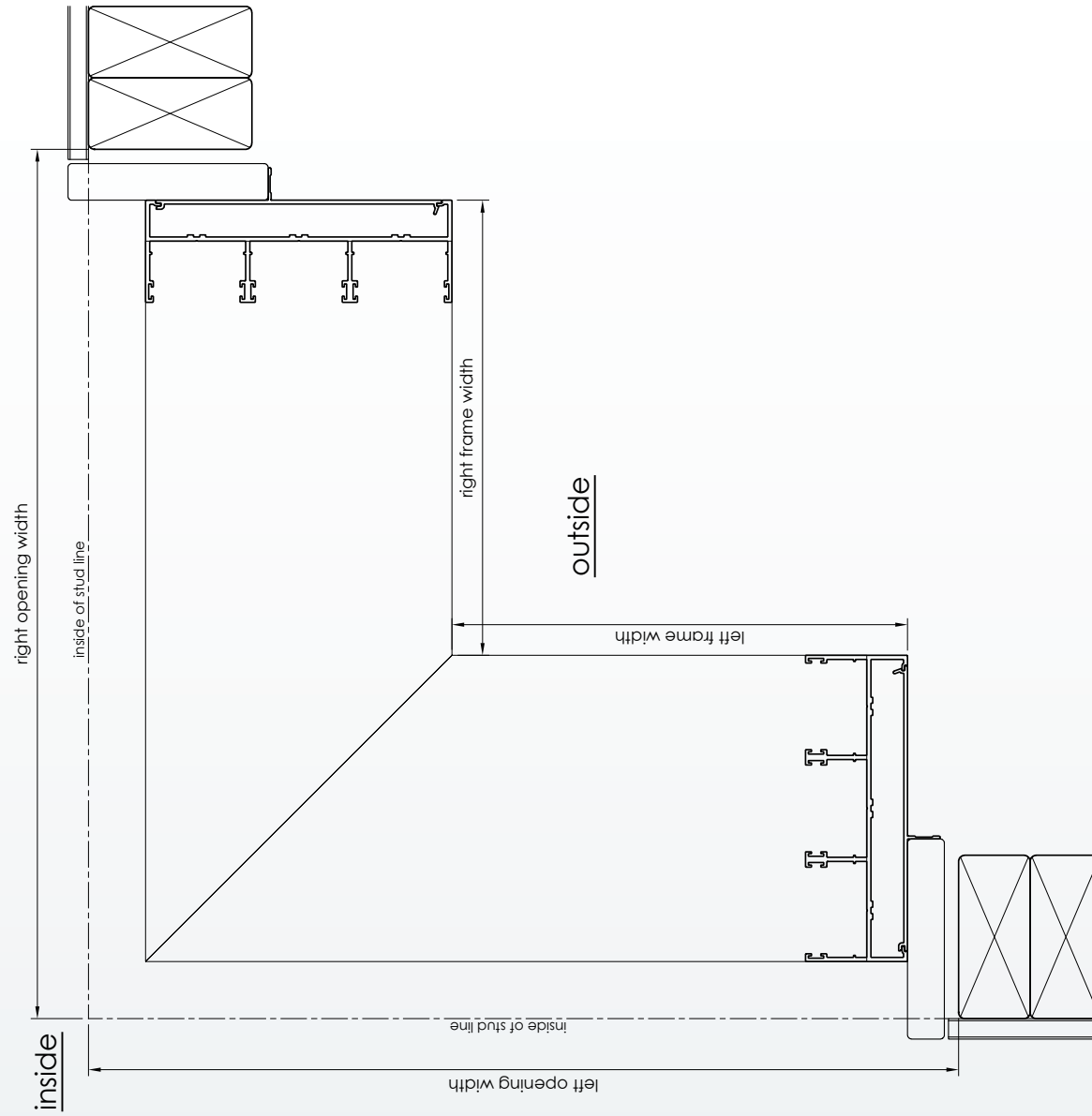

SILL REBATES

Note: Diagrams are not to scale

Signature Corner Sliding Door 100

3001 SILL 3 TRACK

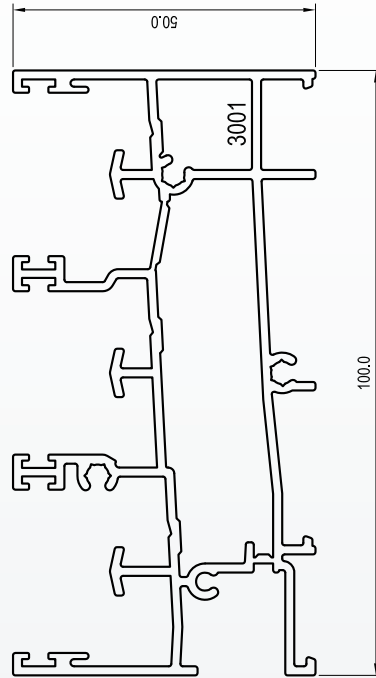

3001 SILL 3 TRACK WITH 3353 SUBSILL '15' 100

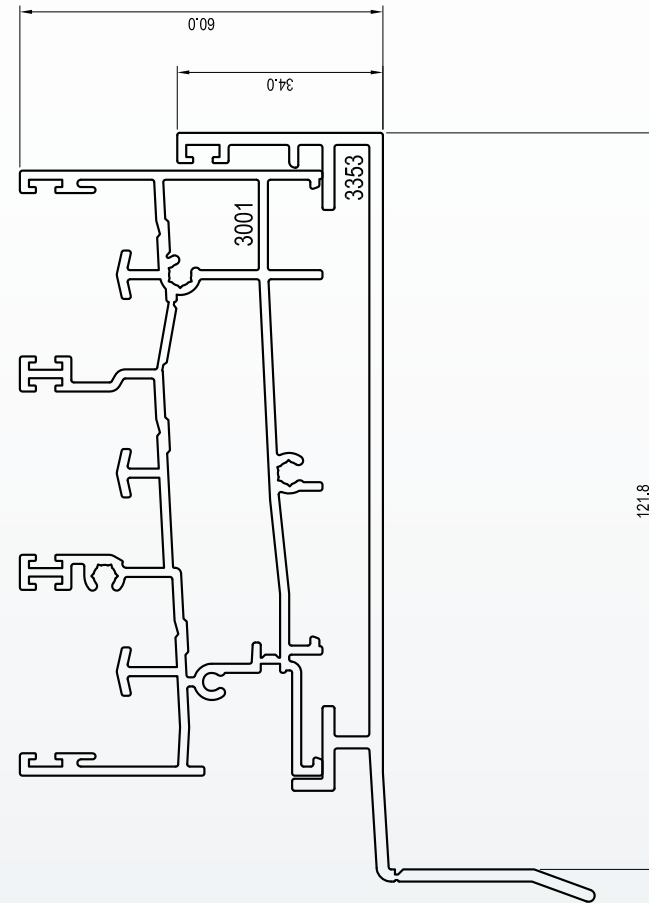

SILL REBATES

Note: Diagrams are not to scale

Signature Corner Sliding Door 100

3001 SILL 3 TRACK WITH 2876 SUBSILL '35' 100

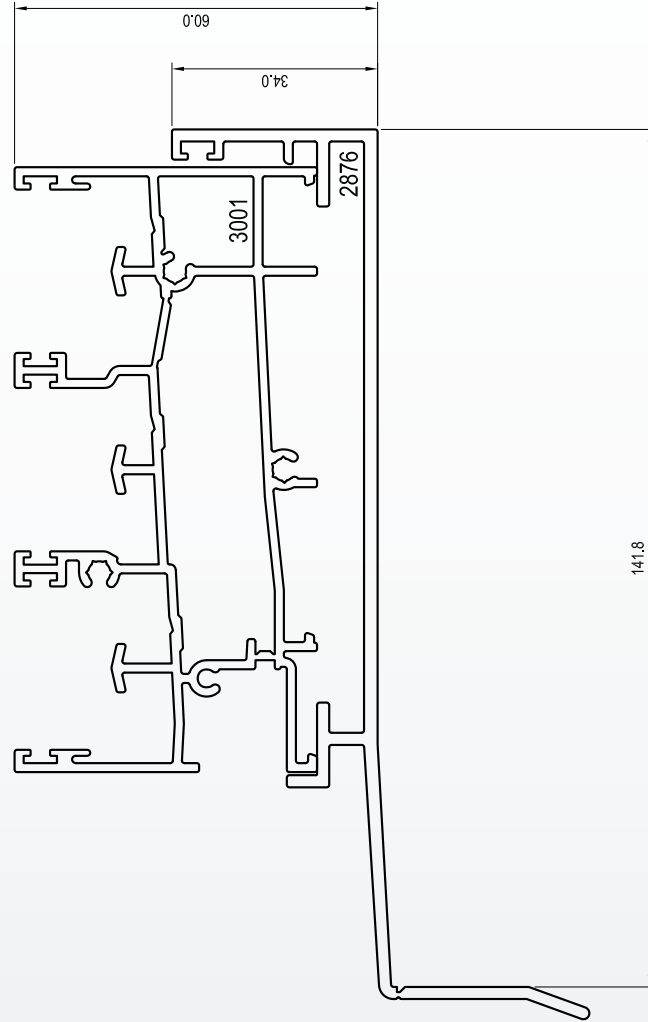

3001 SILL 3 TRACK WITH 3017 SUBSILL BAFFLED 100

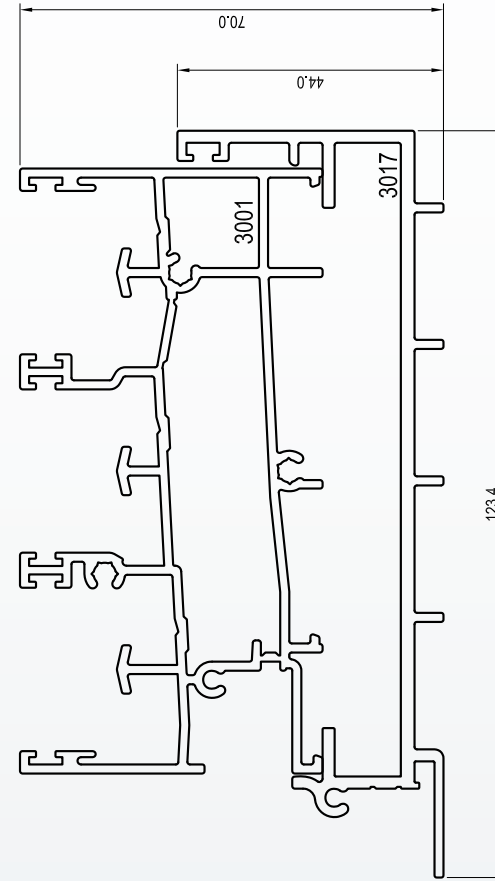

SILL REBATES

Note: Diagrams are not to scale

Signature Corner Sliding Door 100

3012 SILL 3 TRACK 600Pa

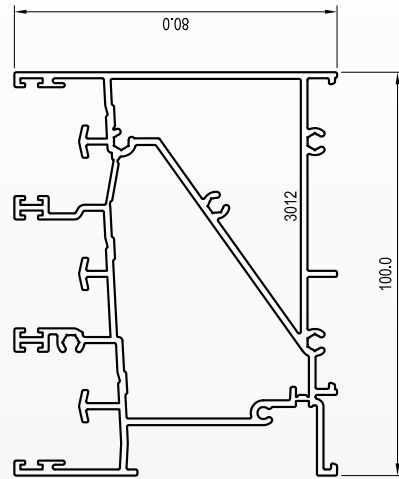

3012 SILL 3 TRACK 600Pa WITH 3353 SUBSILL '15' 100

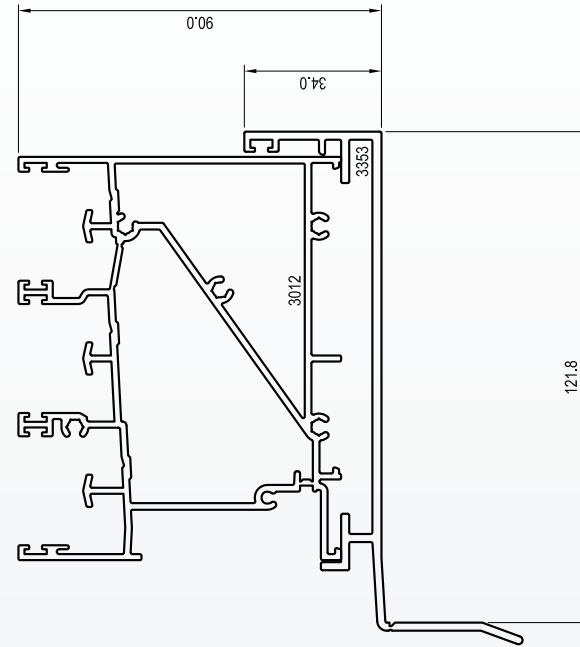

SILL REBATES

Note: Diagrams are not to scale

Signature Corner Sliding Door 100

3012 SILL 3 TRACK 600Pa WITH 2876 SUBSILL '35' 100

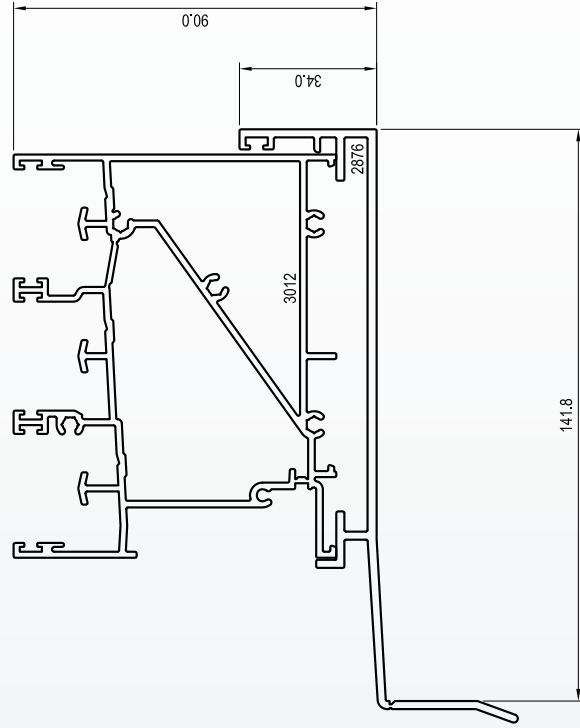

3012 SILL 3 TRACK 600Pa WITH 3017 SUBSILL BAFFLED 100

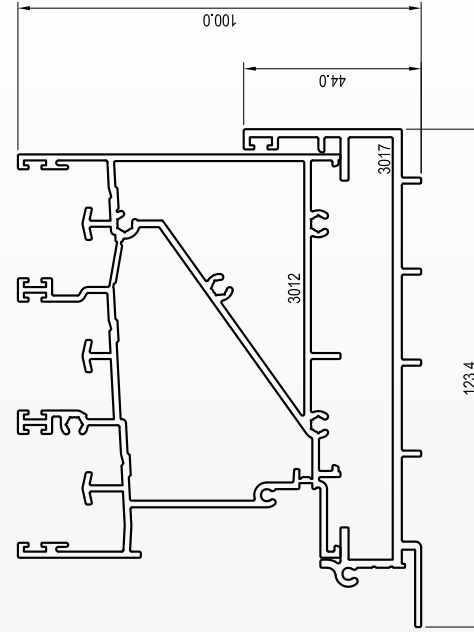

SILL REBATES

Note: Diagrams are not to scale

Signature Corner Sliding Door 100

3434 SILL 100 LP 17

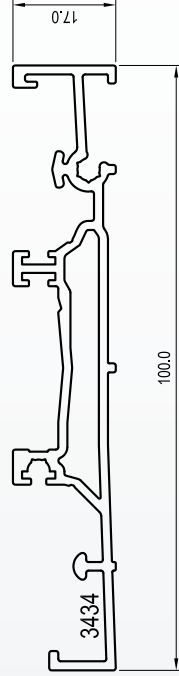

3430 SILL 100 LP 32

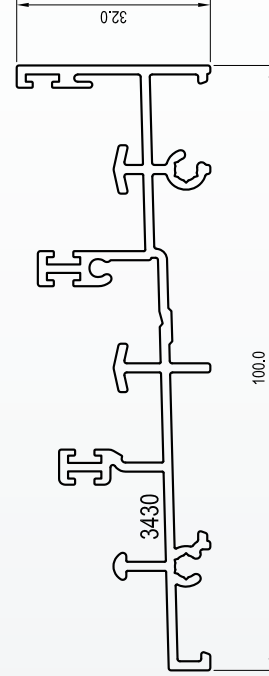

3430 SILL 100 LP 32 WITH 3353 SUBSILL '15' 100

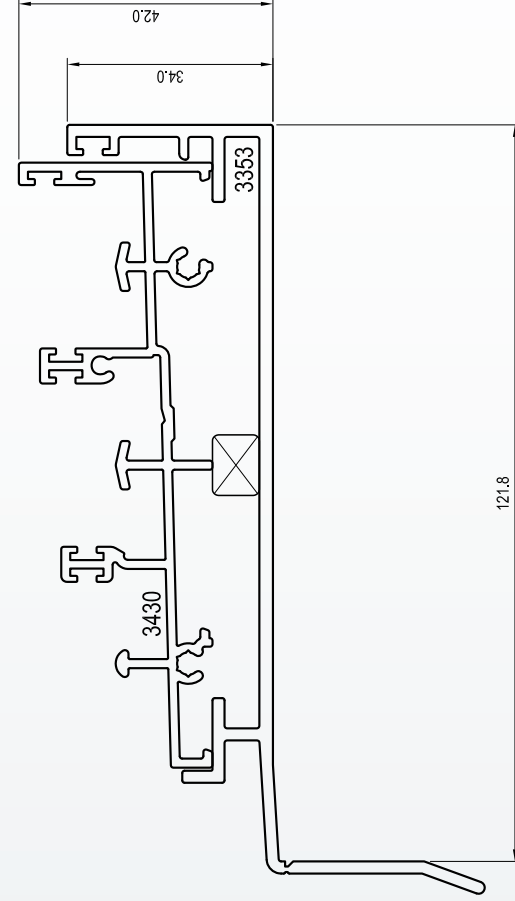

NOTE: REQUIRED PACKING TO BE SUPPLIED & FITTED BY BRADNAM'S OR LICENSEE.

SILL REBATES

Note: Diagrams are not to scale

Signature Corner Sliding Door 100

3430 SILL 100 LP 32 WITH 2876 SUBSILL '35' 100

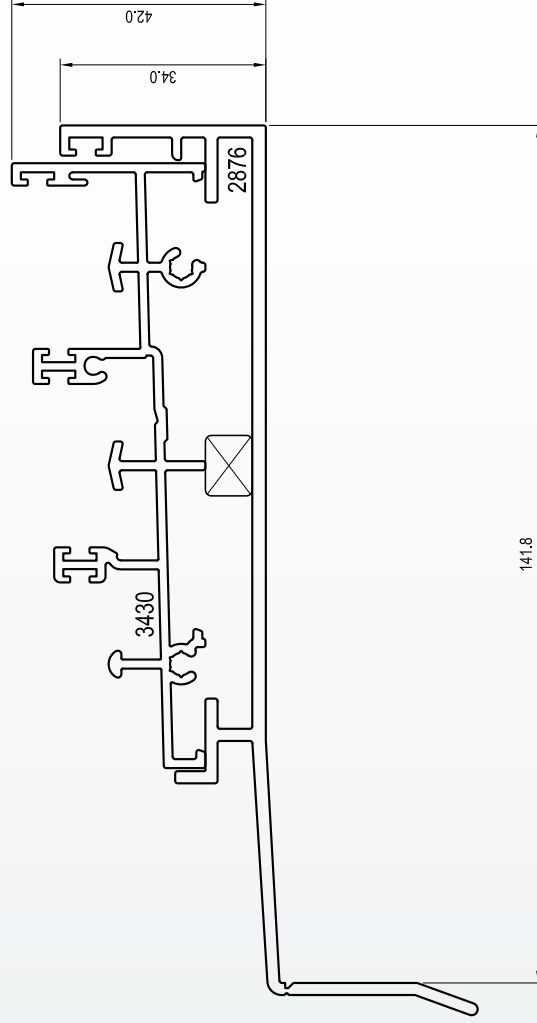

NOTE: REQUIRED PACKING TO BE SUPPLIED & FITTED BY BRADNAM'S OR LICENSEE.

3430 SILL 100 LP 32 WITH 3017 SUBSILL BAFFLED 100

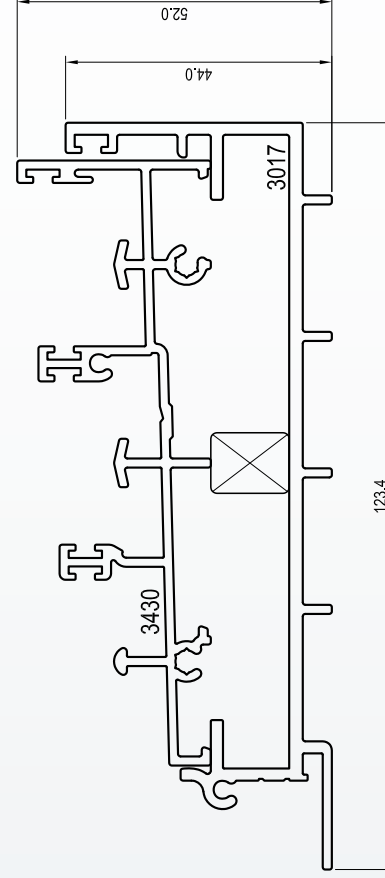

NOTE: REQUIRED PACKING TO BE SUPPLIED & FITTED BY BRADNAM'S OR LICENSEE.

SILL REBATES

Note: Diagrams are not to scale

Signature Corner Sliding Door 100

3001 SILL 3 TRACK & 3038 SILL PLANT-ON

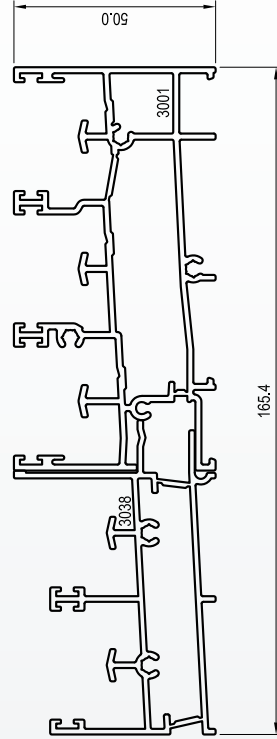

3001 SILL 3 TRACK & 3038 SILL PLANT-ON WITH 3349 SUBSILL '15' 166

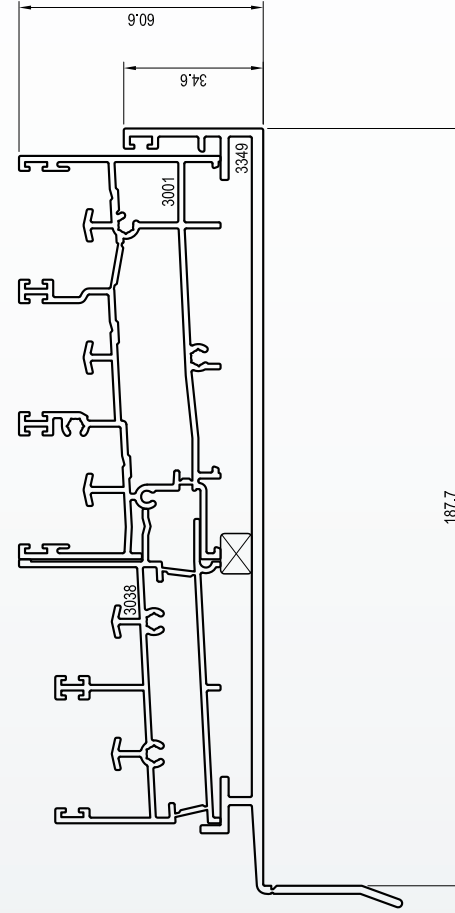

NOTE: REQUIRED PACKING TO BE SUPPLIED & FITTED BY BRADNAM'S OR LICENSEE.

SILL REBATES

Note: Diagrams are not to scale

Signature Corner Sliding Door 100

3001 SILL 3 TRACK & 3038 SILL PLANT-ON WITH 3374 SUBSILL BAFFLED 166

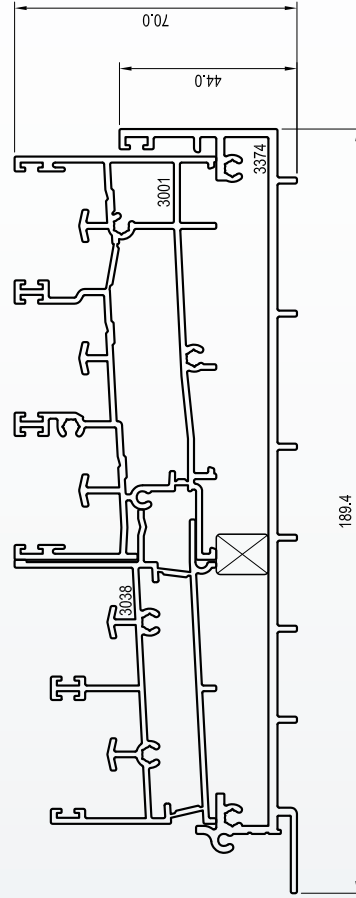

NOTE: REQUIRED PACKING TO BE SUPPLIED & FITTED BY BRADNAM'S OR LICENSEE.

3001 SILL 3 TRACK & 3038 SILL PLANT-ON WITH 3335 & 3337 SUBSILLS

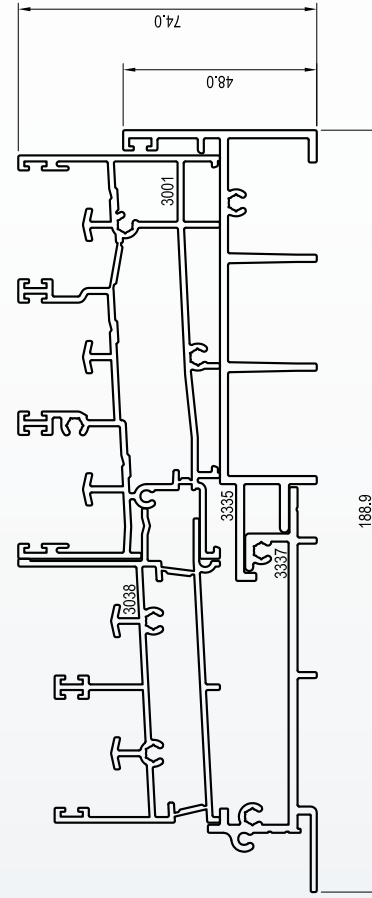

SILL REBATES

Note: Diagrams are not to scale

Signature Corner Sliding Door 100

3012 SILL 3 TRACK 600Pa & 3038 SILL PLANT-ON

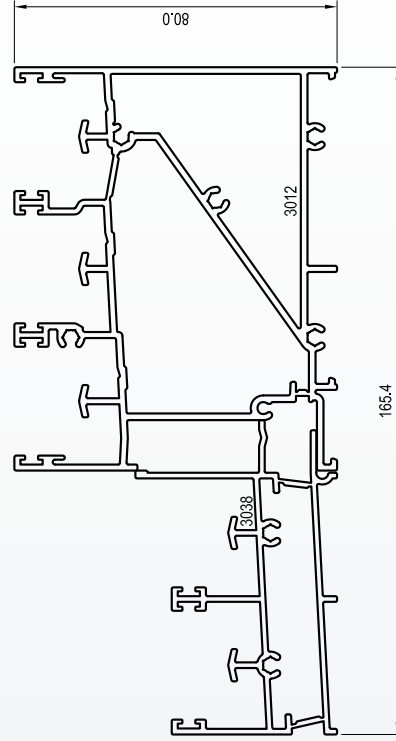

3012 SILL 3 TRACK 600Pa & 3038 SILL PLANT-ON WITH 3349 SUBSILL '15' 166

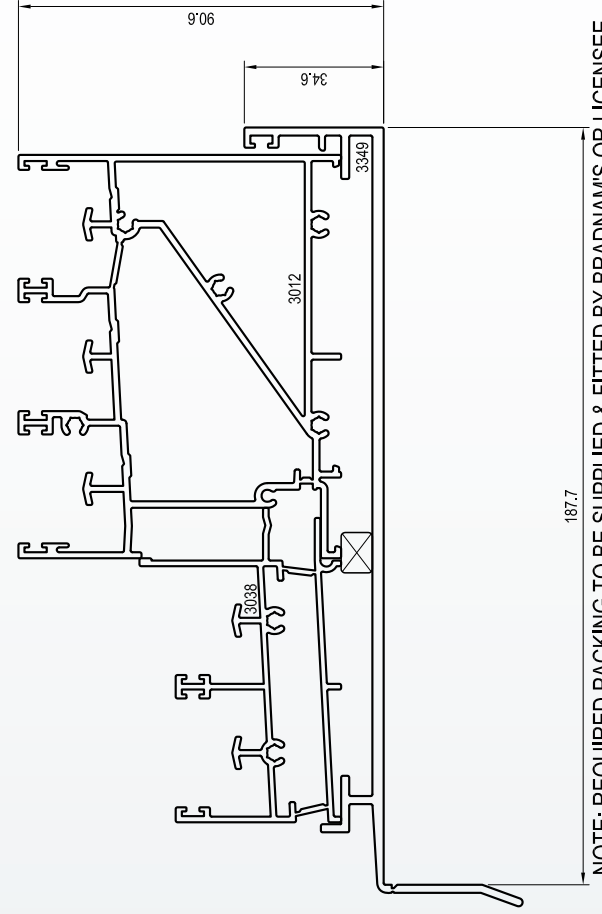

NOTE: REQUIRED PACKING TO BE SUPPLIED & FITTED BY BRADNAM'S OR LICENSEE.

SILL REBATES

Note: Diagrams are not to scale

Signature Corner Sliding Door 100

3012 SILL 3 TRACK 600Pa & 3038 SILL PLANT-ON WITH 3374 SUBSILL BAFFLED 166

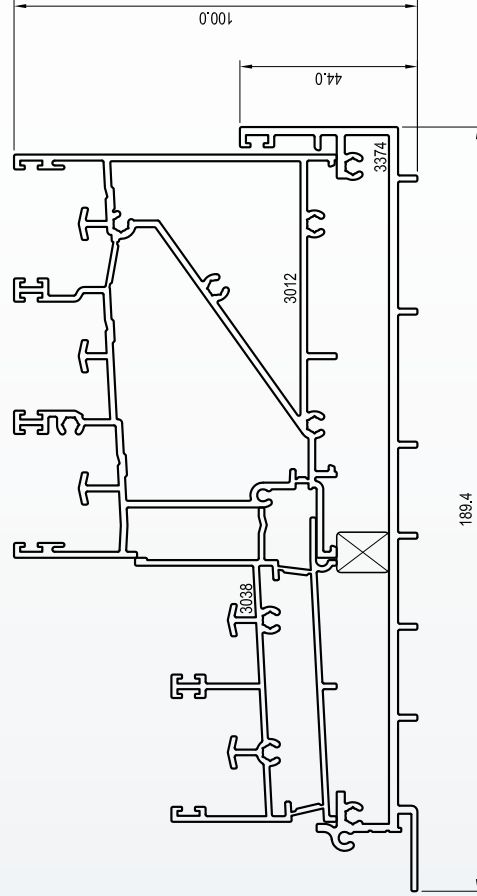

NOTE: REQUIRED PACKING TO BE SUPPLIED & FITTED BY BRADNAM'S OR LICENSEE.

3012 SILL 3 TRACK 600Pa & 3038 SILL PLANT-ON WITH 3335 & 3337 SUBSILLS

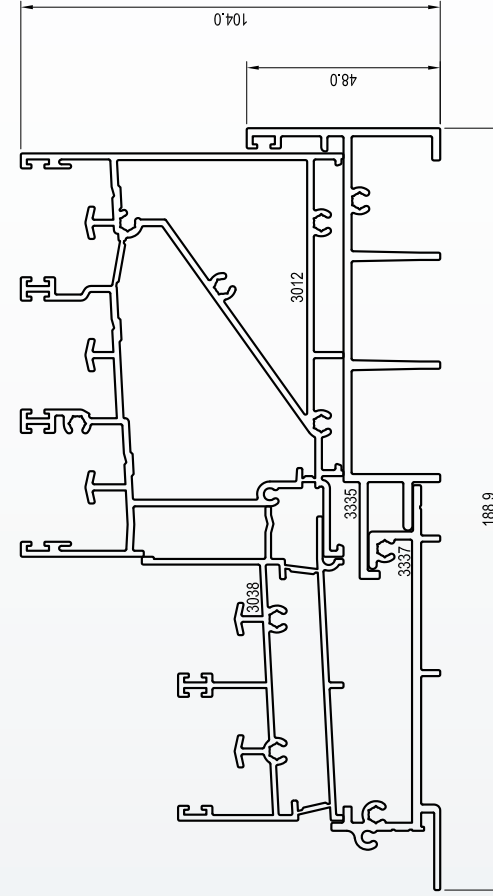

SILL REBATES

Note: Diagrams are not to scale

Signature Corner Sliding Door 166

3033 SILL 5 TRACK

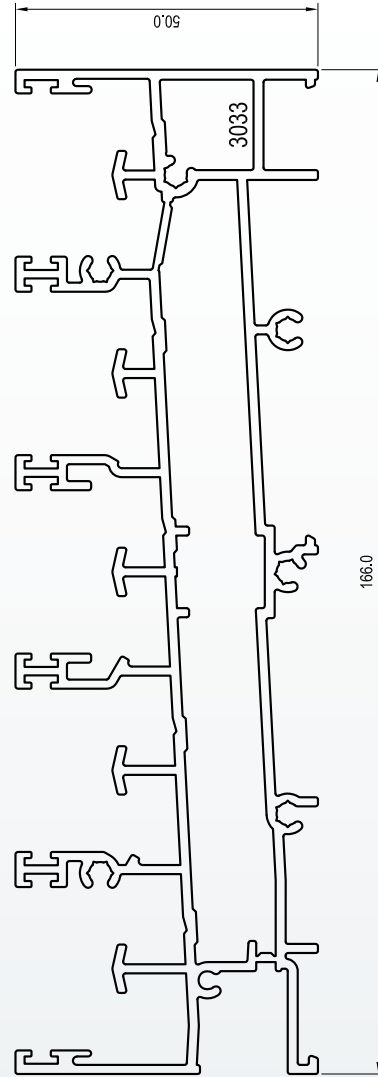

3435 SILL 166 LP 17

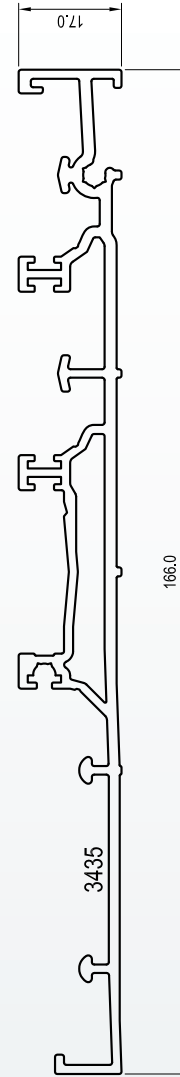

3431 SILL 166 LP 32

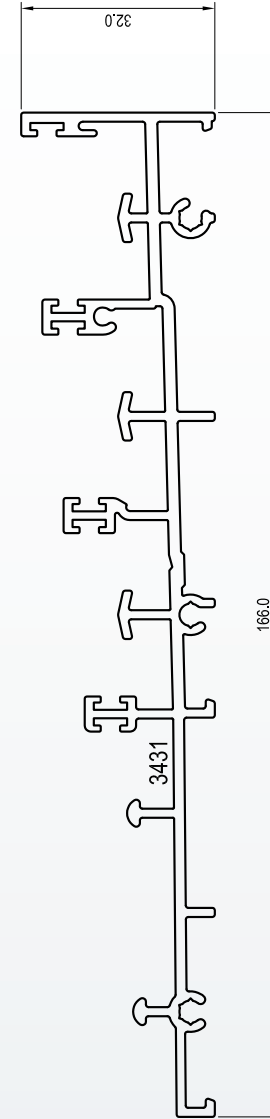

SILL REBATES

Note: Diagrams are not to scale

Signature Corner Sliding Door 166

3033 SILL 5 TRACK WITH 3349 SUBSILL '15' 166

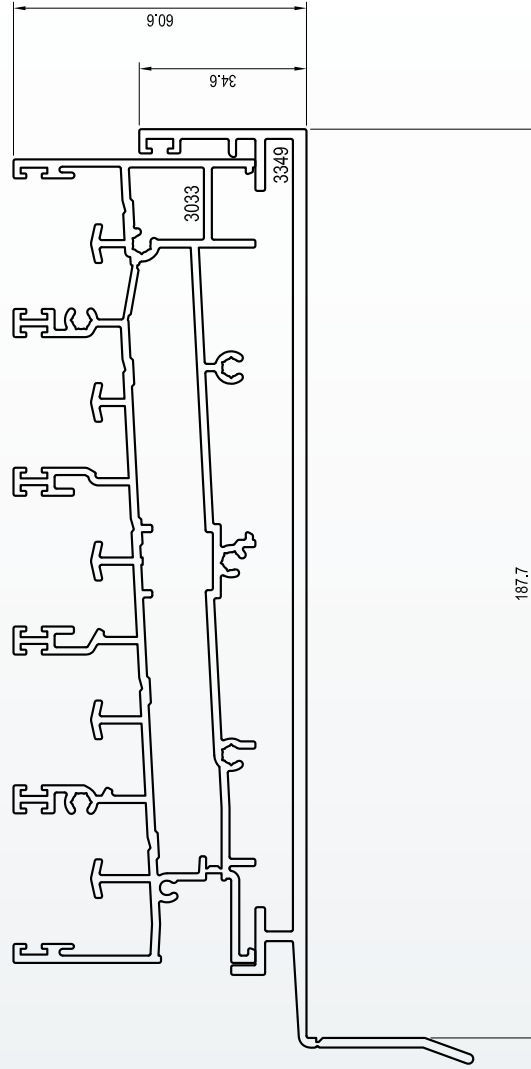

3033 SILL 5 TRACK WITH 3374 SUBSILL BAFFLED 166

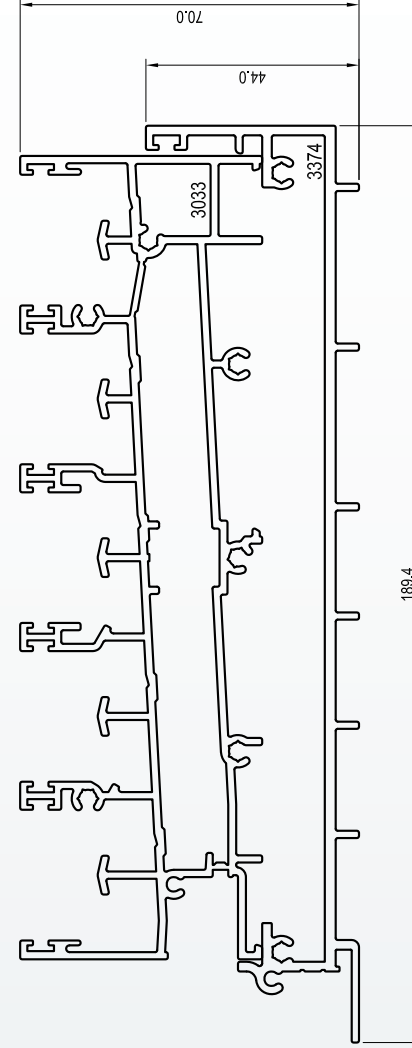

SILL REBATES

Note: Diagrams are not to scale

Signature Corner Sliding Door 166

3431 SILL 166 LP 32 WITH 3349 SUBSILL '15' 166

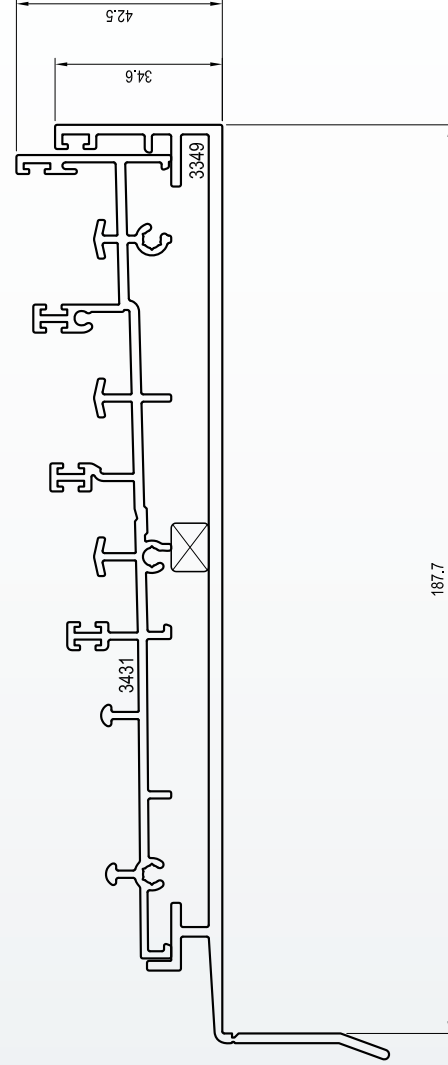

NOTE: REQUIRED PACKING TO BE SUPPLIED & FITTED BY BRADNAM'S OR LICENSEE.

3431 SILL 166 LP 32 WITH 3374 SUBSILL BAFFLED 166

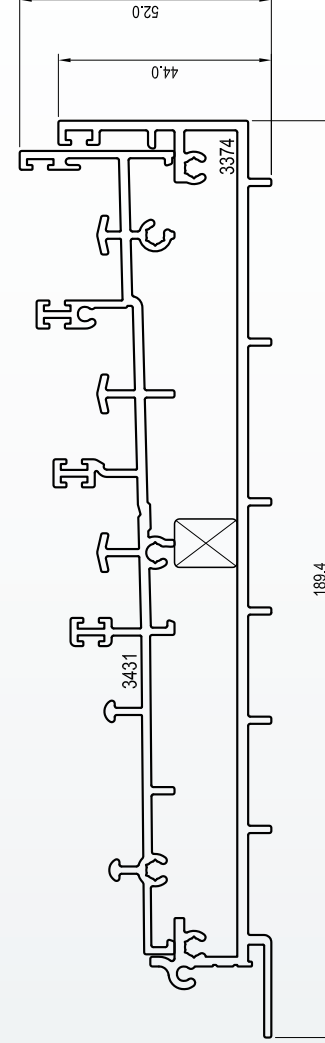

NOTE: REQUIRED PACKING TO BE SUPPLIED & FITTED BY BRADNAM'S OR LICENSEE.

SILL REBATES

Note: Diagrams are not to scale

Signature Corner Sliding Door 166

3033 SILL 5 TRACK & 3038 SILL PLANT-ON

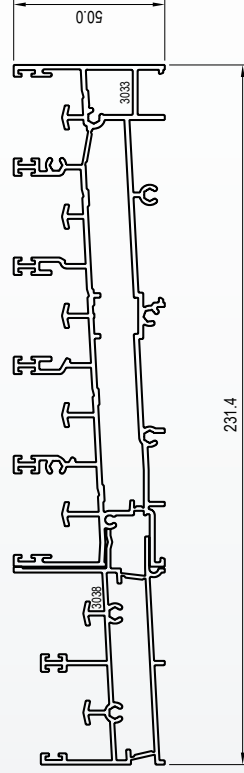

3033 SILL 5 TRACK & 3370 SILL 4 TRACK WITH 3372 ADAPTOR 4 TRACK

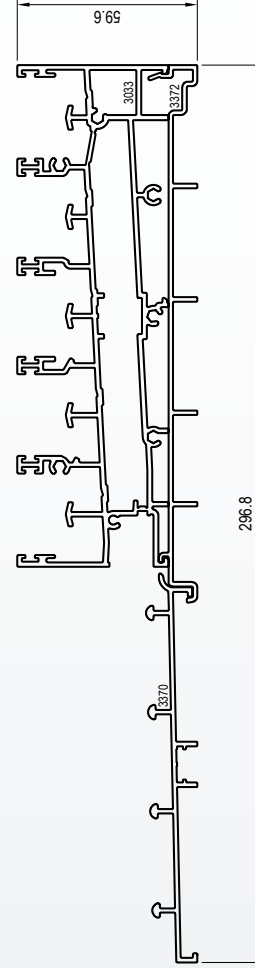

3033 SILL 5 TRACK & 3370 SILL 4 TRACK WITH 3374 SUBSILL BAFFLED 166

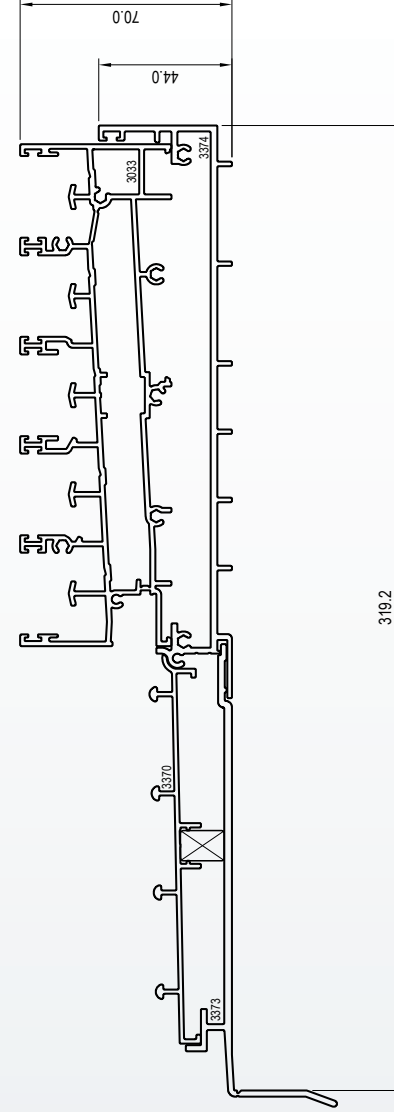

NOTE: REQUIRED PACKING TO BE SUPPLIED & FITTED BY BRADNAM'S OR LICENSEE.

SILL REBATES

Note: Diagrams are not to scale

Signature Corner Sliding Door 100

3434 SILL 100 LP 17 WITH 3115 RAMP UPPER

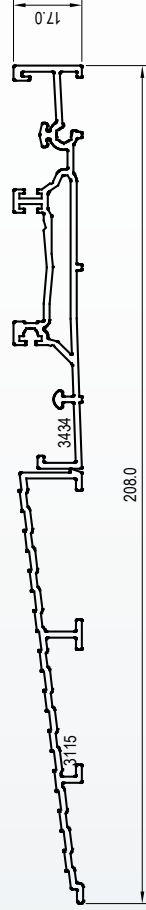

3430 SILL 100 LP 32 WITH 3115 RAMP UPPER

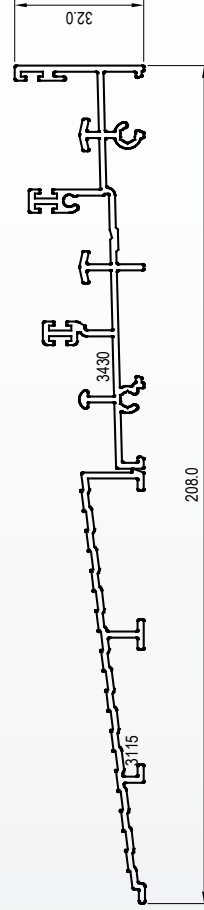

3430 SILL 100 LP 32 WITH 3115 RAMP UPPER & 3116 RAMP LOWER

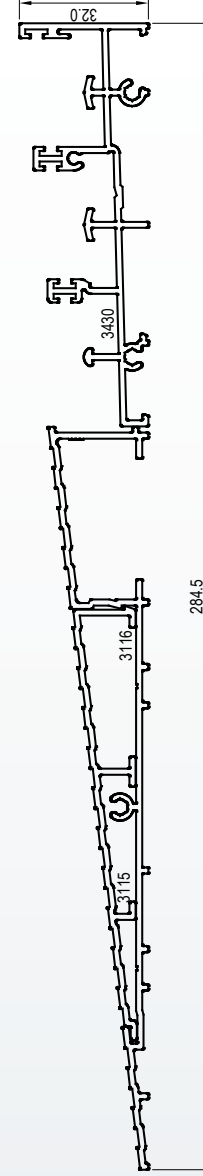

NOTE: REQUIRED PACKING TO BE SUPPLIED & FITTED BY BRADNAM'S OR LICENSEE.

SILL REBATES

Note: Diagrams are not to scale

Commercial Corner Sliding Door 100

2552 SILL 2 TRACK STD

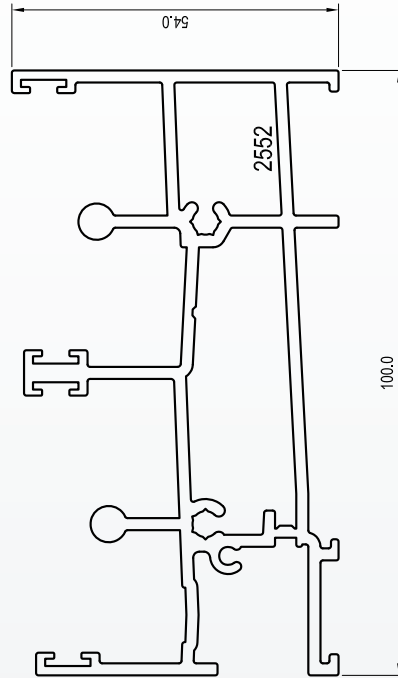

2552 SILL 2 TRACK STD WITH 3353 SUBSILL '15' 100

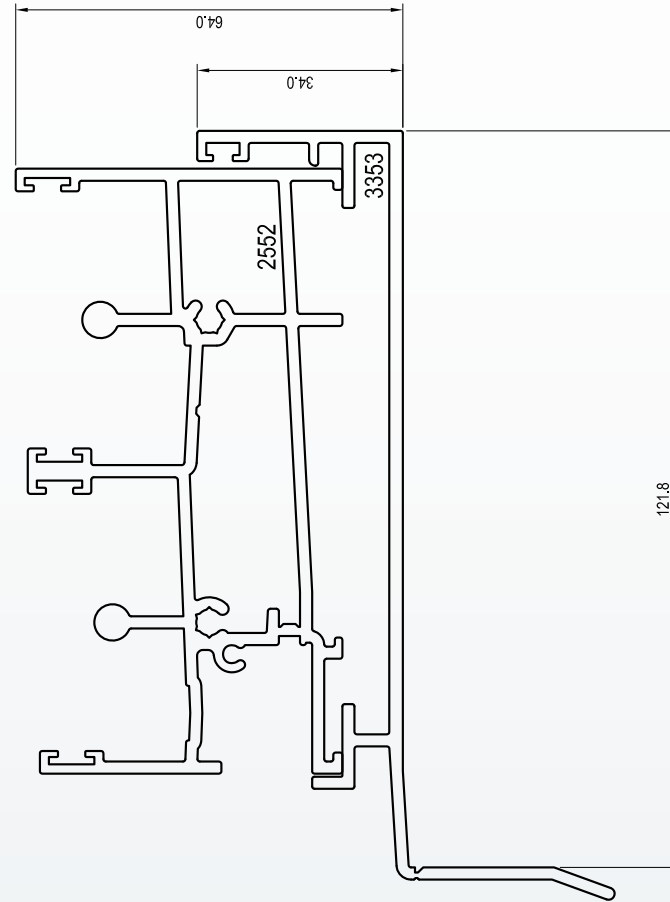

SILL REBATES

Note: Diagrams are not to scale

Commercial Corner Sliding Door 100

2552 SILL 2 TRACK STD WITH 2876 SUBSILL '35' 100

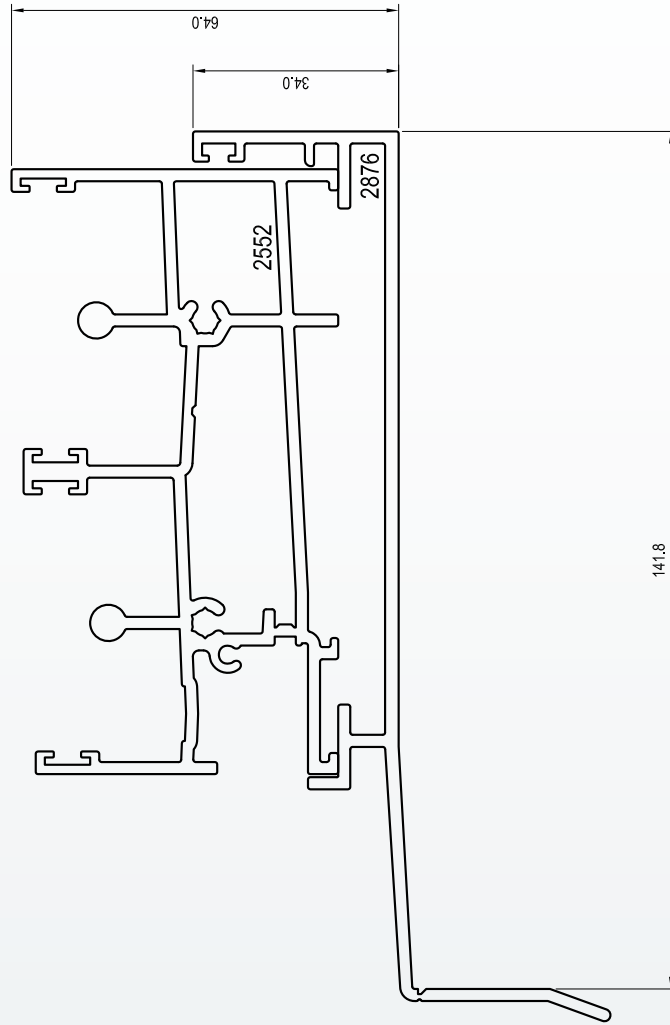

2552 SILL 2 TRACK STD WITH 3017 SUBSILL BAFFLED 100

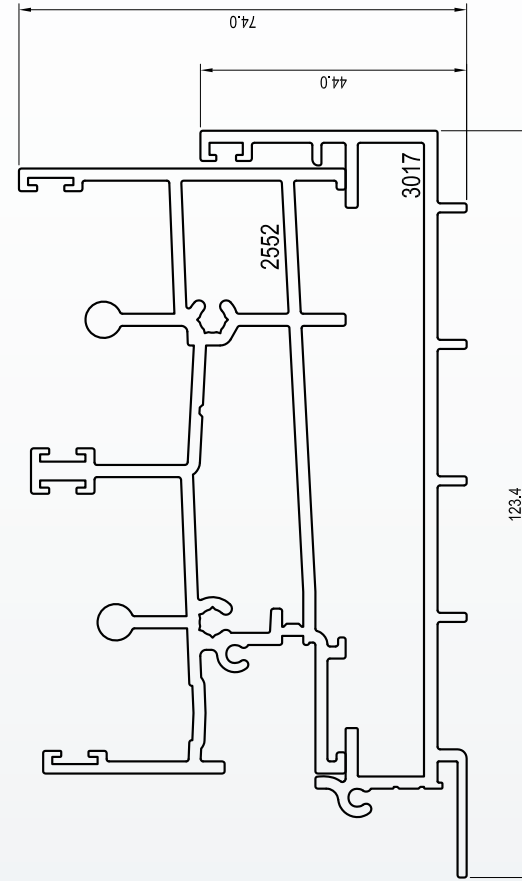

SILL REBATES

Note: Diagrams are not to scale

Commercial Corner Sliding Door 100

2580 SILL 2 TRACK HP

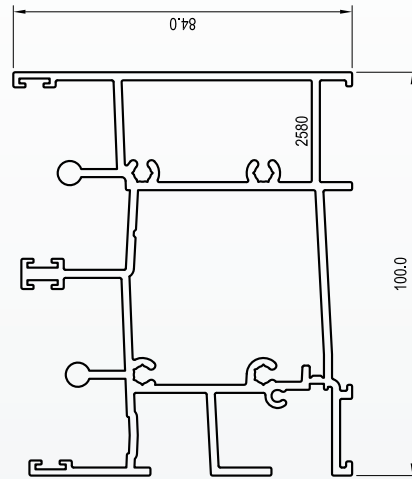

2580 SILL 2 TRACK HP WITH 3353 SUBSILL '15' 100

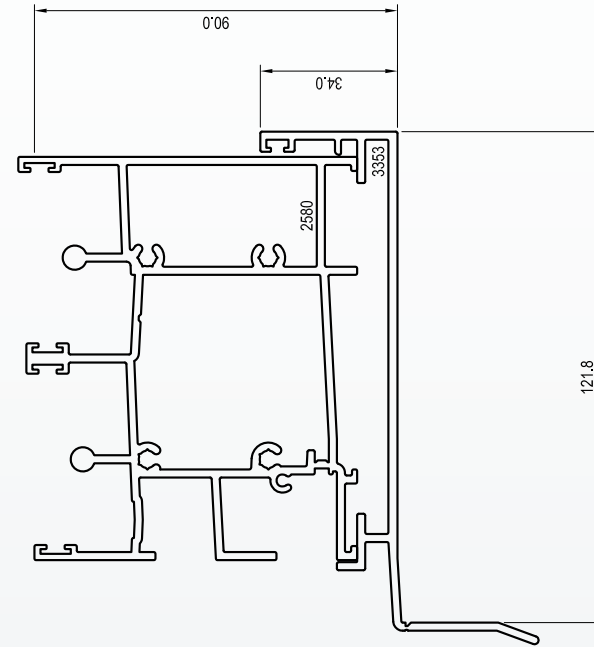

SILL REBATES

Note: Diagrams are not to scale

Commercial Corner Sliding Door 100

2580 SILL 2 TRACK HP WITH 2876 SUBSILL '35' 100

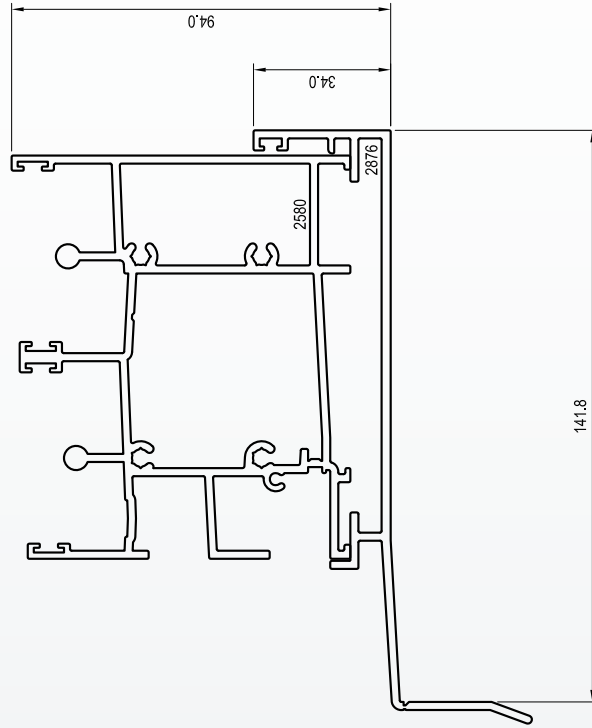

2580 SILL 2 TRACK HP WITH 3017 SUBSILL BAFFLED 100

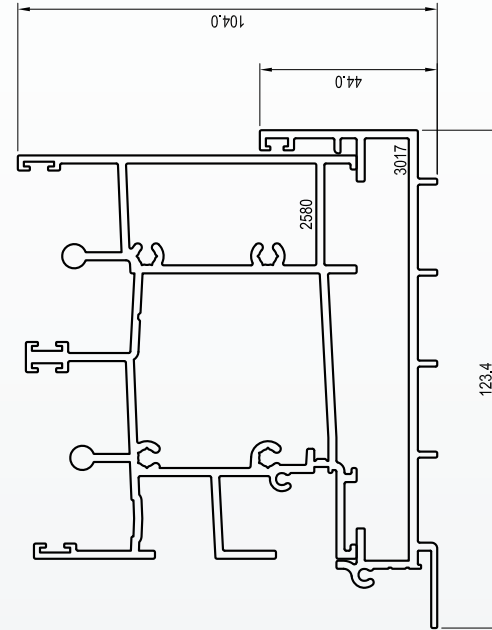

SILL REBATES

Note: Diagrams are not to scale

Commercial Corner Sliding Door 100

2552 SILL 2 TRACK STD & 3038 SILL PLANT-ON

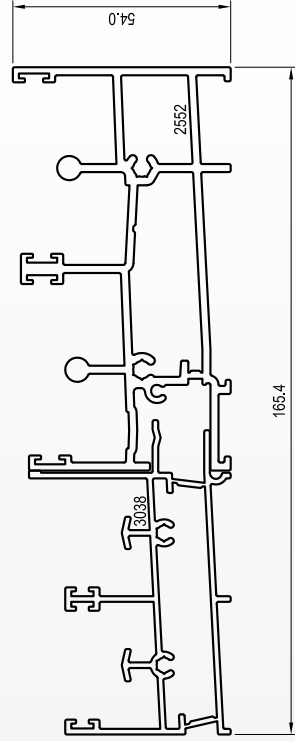

2552 SILL 2 TRACK STD & 3038 SILL PLANT-ON WITH 3349 SUBSILL '15' 166

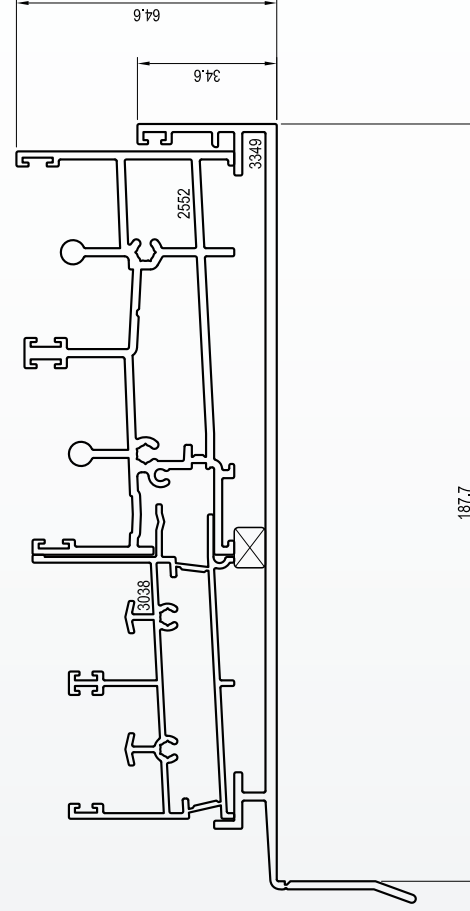

NOTE: REQUIRED PACKING TO BE SUPPLIED & FITTED BY BRADNAM'S OR LICENSEE.

SILL REBATES

Note: Diagrams are not to scale

Commercial Corner Sliding Door 100

2552 SILL 2 TRACK STD & 3038 SILL PLANT-ON WITH 3374 SUBSILL BAFFLED 166

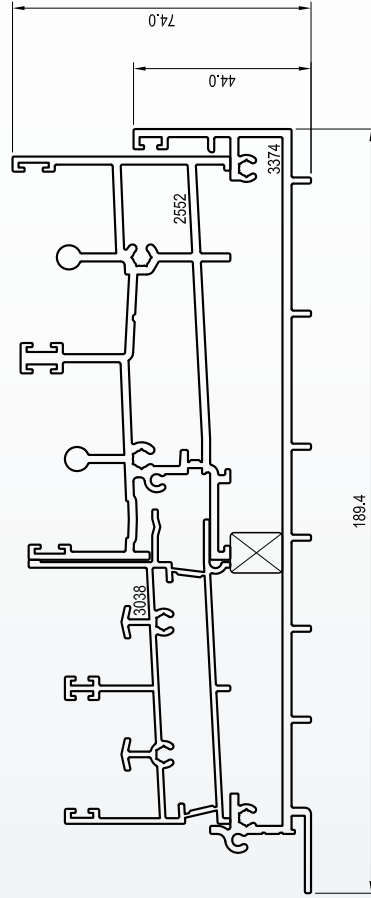

NOTE: REQUIRED PACKING TO BE SUPPLIED & FITTED BY BRADNAM'S OR LICENSEE.

2552 SILL 2 TRACK STD & 3038 SILL PLANT-ON WITH 3335 & 3337 SUBSILLS

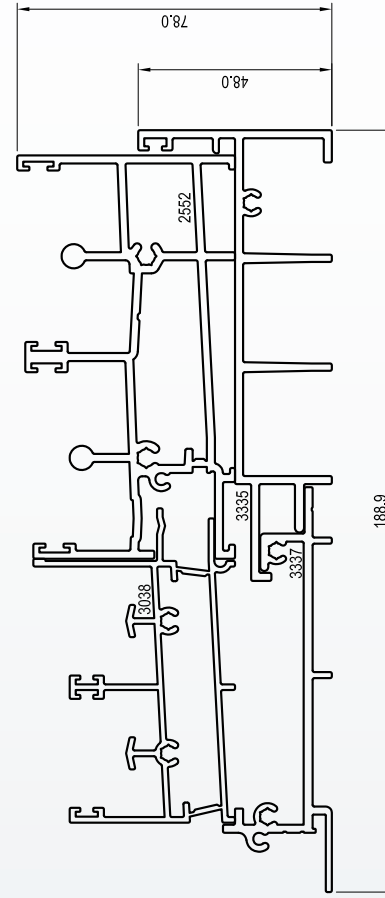

SILL REBATES

Note: Diagrams are not to scale

Commercial Corner Sliding Door 100

2580 SILL 2 TRACK HP & 3038 SILL PLANT-ON

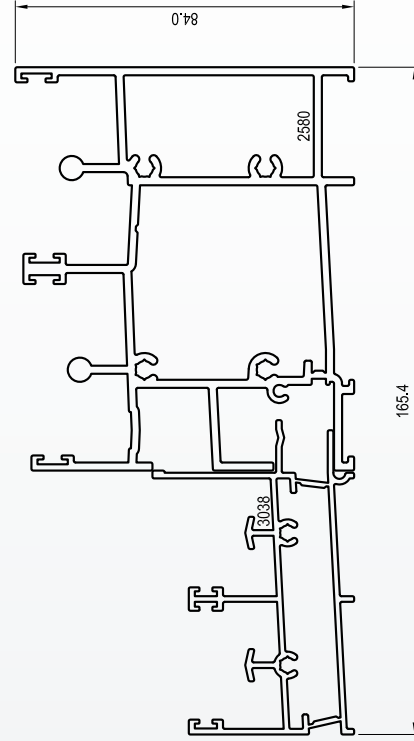

2580 SILL 2 TRACK HP & 3038 SILL PLANT-ON WITH 3349 SUBSILL '15' 166

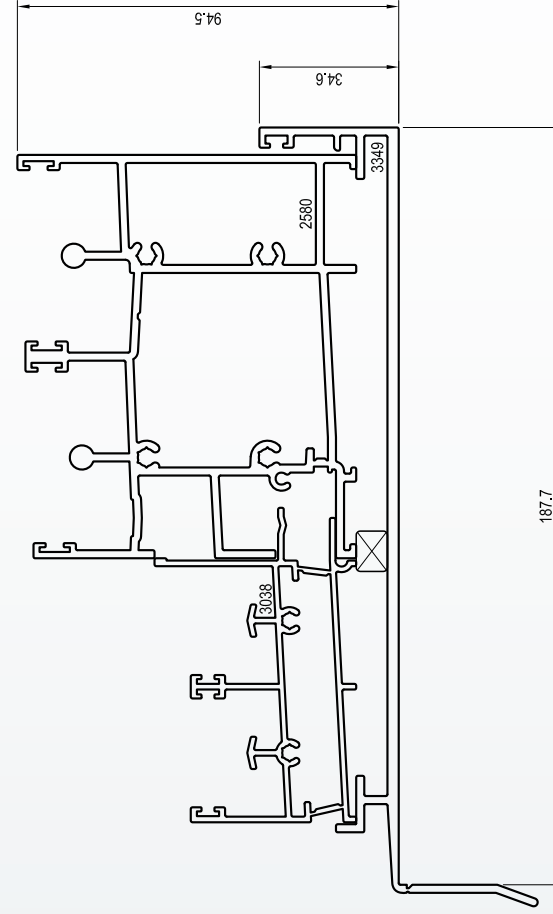

NOTE: REQUIRED PACKING TO BE SUPPLIED & FITTED BY BRADNAM'S OR LICENSEE.

SILL REBATES

Note: Diagrams are not to scale

Commercial Corner Sliding Door 100

2580 SILL 2 TRACK HP & 3038 SILL PLANT-ON WITH 3374 SUBSILL BAFFLED 166

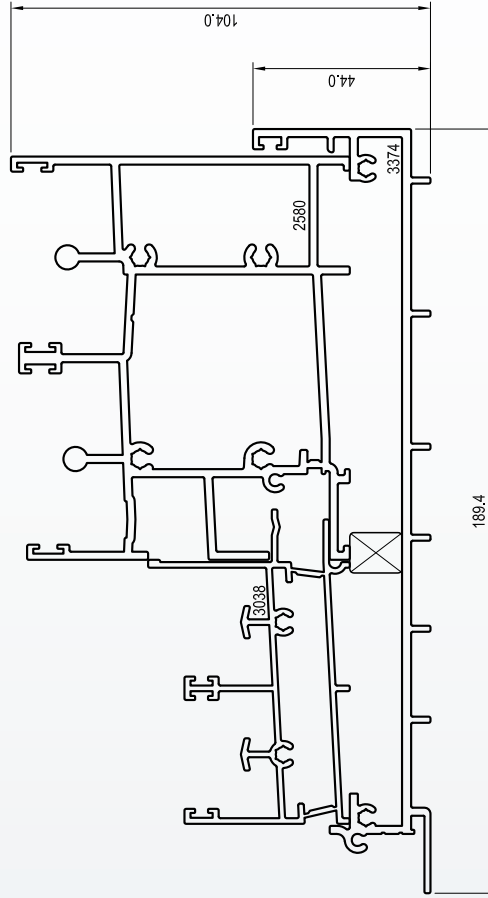

NOTE: REQUIRED PACKING TO BE SUPPLIED & FITTED BY BRADNAM'S OR LICENSEE.

2580 SILL 2 TRACK HP & 3038 SILL PLANT-ON WITH 3335 & 3337 SUBSILLS

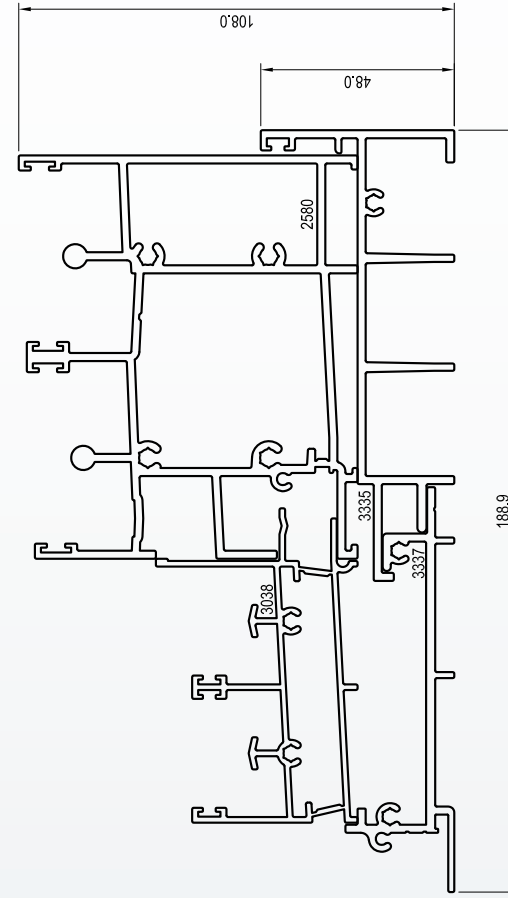

SILL REBATES

Note: Diagrams are not to scale

Commercial Corner Sliding Door 150

2572 SILL 3 TRACK STD

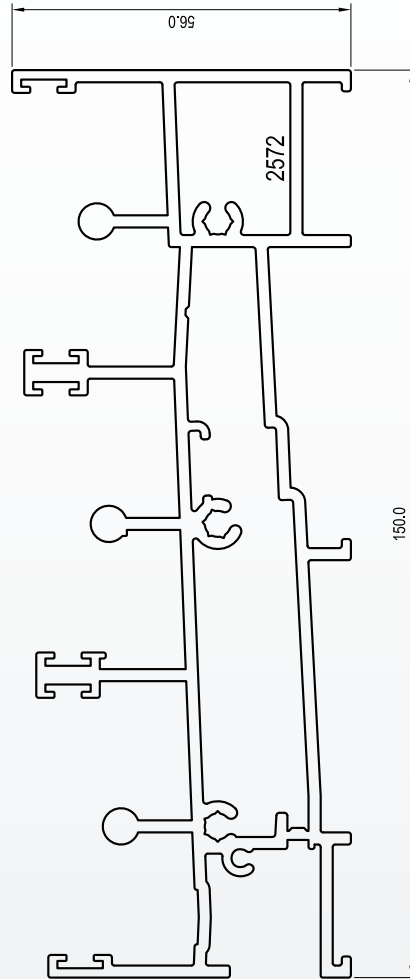

2572 SILL 3 TRACK STD WITH 2879 SUBSILL '7' 150

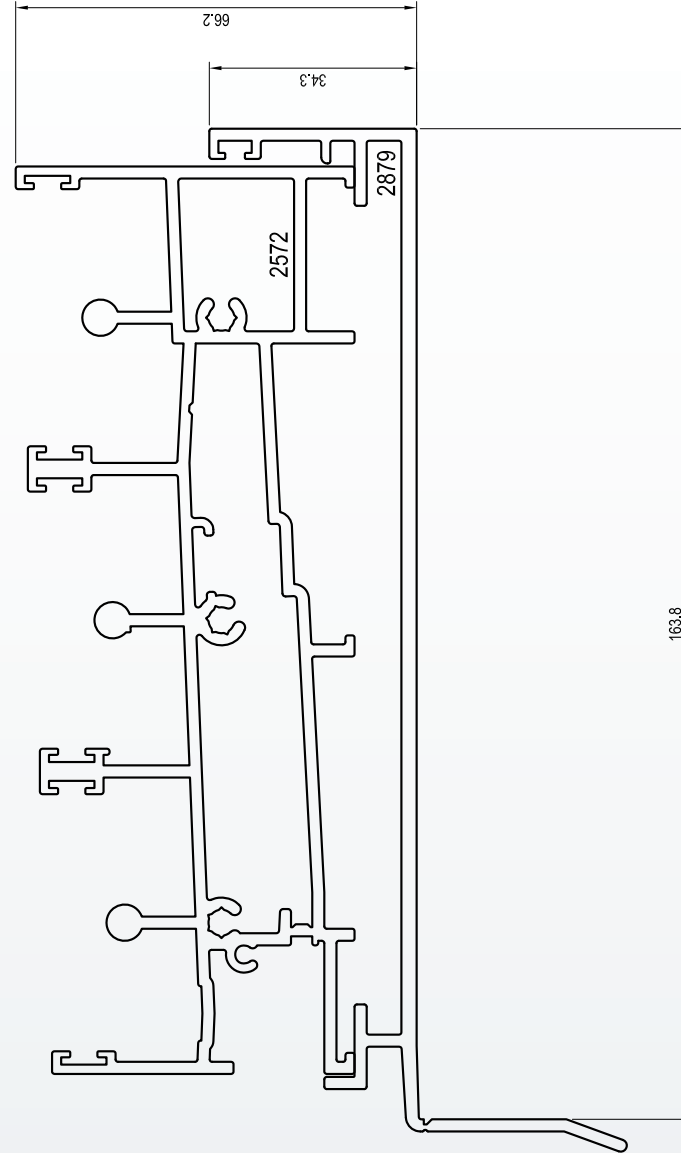

SILL REBATES

Note: Diagrams are not to scale

Commercial Corner Sliding Door 150

2581 SILL 3 TRACK HP

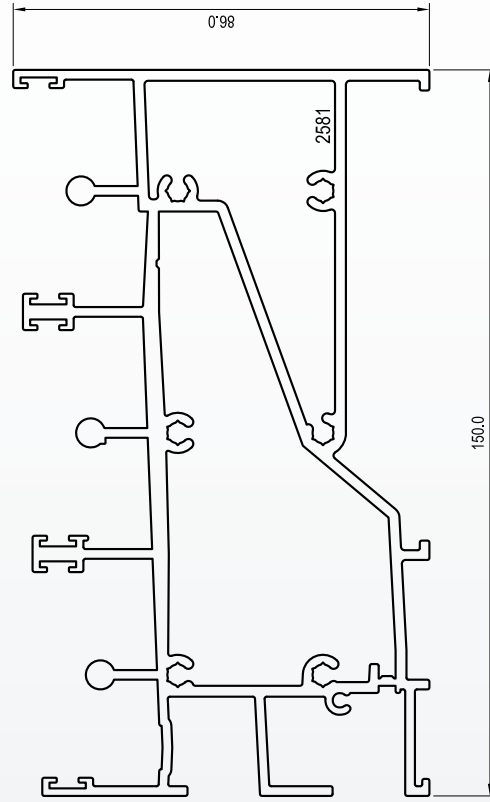

2581 SILL 3 TRACK HP WITH 2879 SUBSILL '7' 150

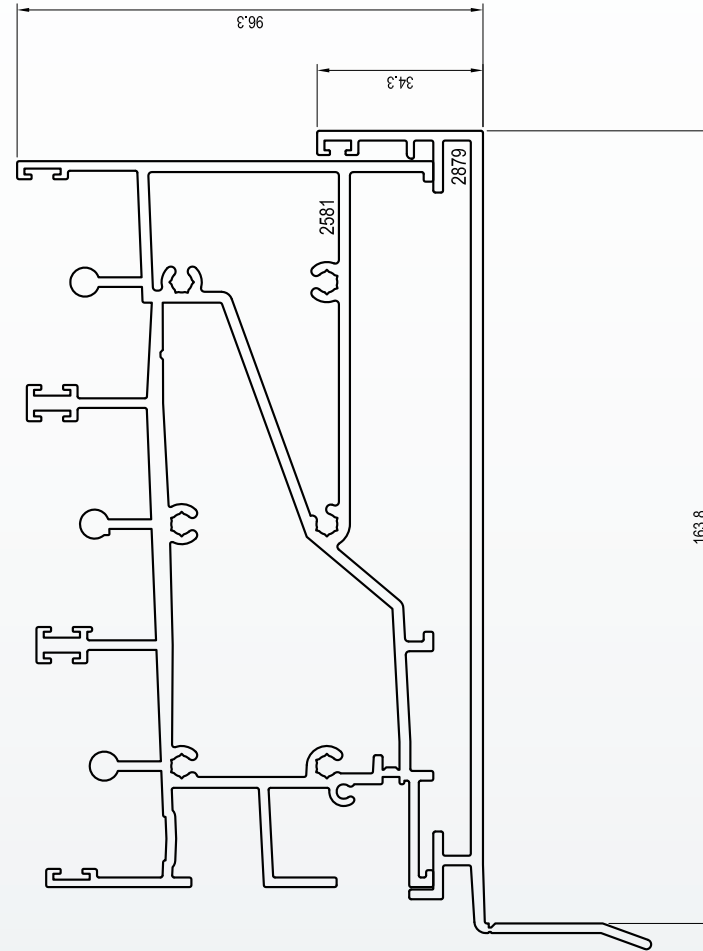

SILL REBATES

Note: Diagrams are not to scale

Commercial Corner Sliding Door 150

2572 SILL 3 TRACK STD & 3038 SILL PLANT-ON

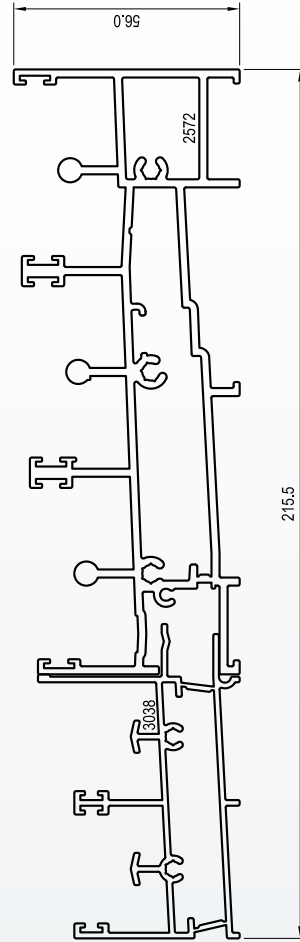

2572 SILL 3 TRACK STD & 3038 SILL PLANT-ON WITH 3336 & 3337 SUBSILLS

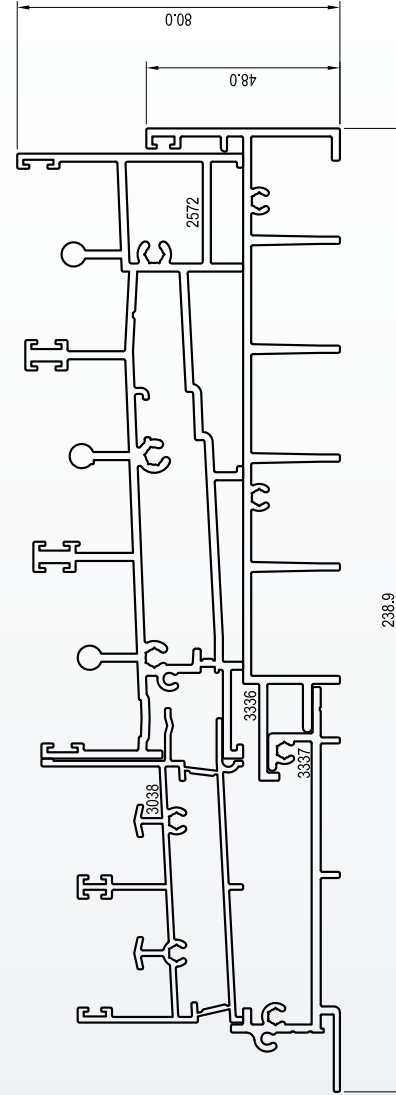

SILL REBATES

Note: Diagrams are not to scale

Commercial Corner Sliding Door 150

2581 SILL 3 TRACK HP & 3038 SILL PLANT-ON

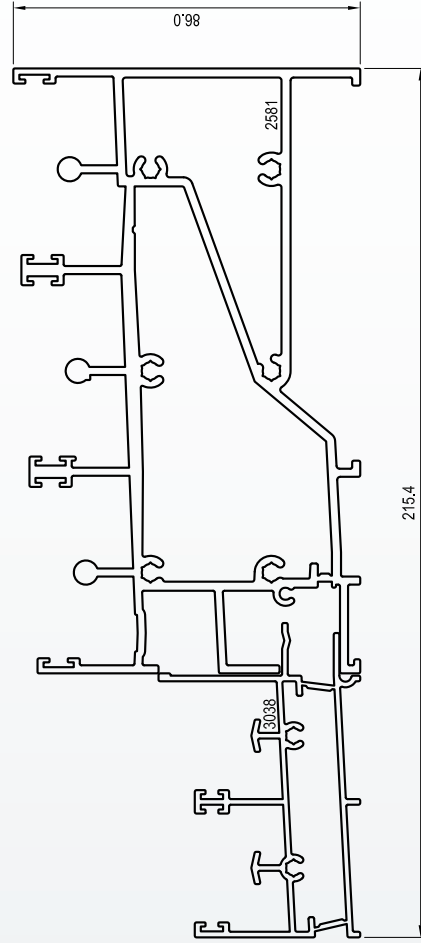

2581 SILL 3 TRACK HP & 3038 SILL PLANT-ON WITH 3336 & 3337 SUBSILLS

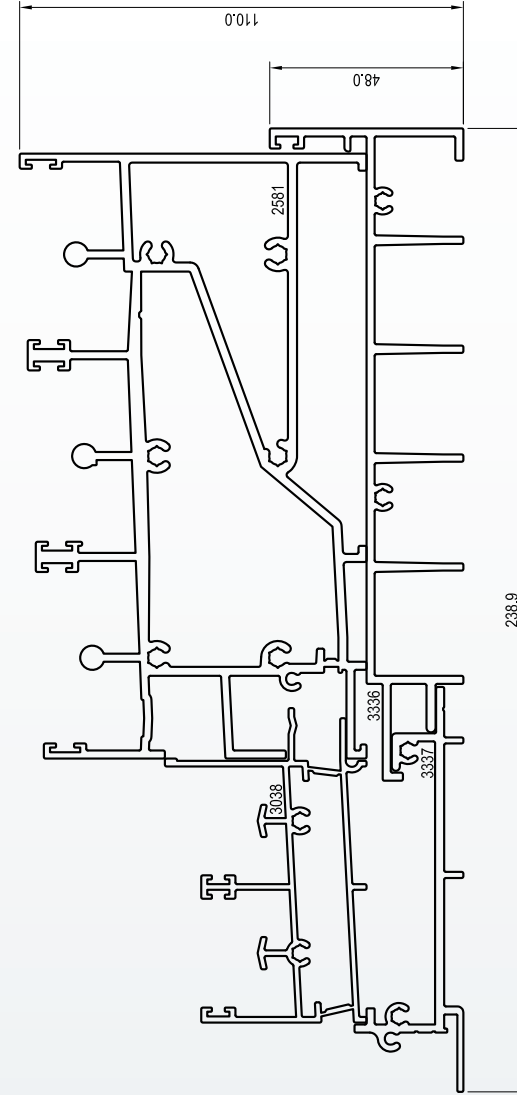

SILL REBATES

Note: Diagrams are not to scale

Commercial Corner Sliding Door 100 & 150

3439 SILL 2 TRACK LP

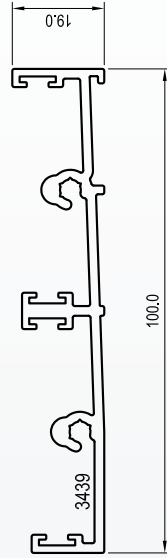

3439 SILL 2 TRACK LP WITH 3438 SILL PLANT-ON LP

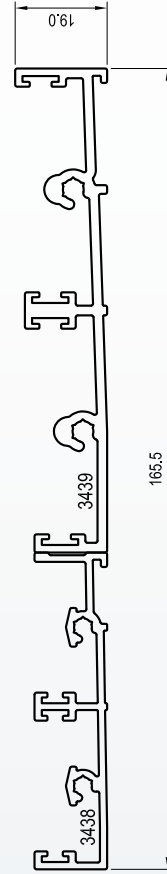

3440 SILL 3 TRACK LP

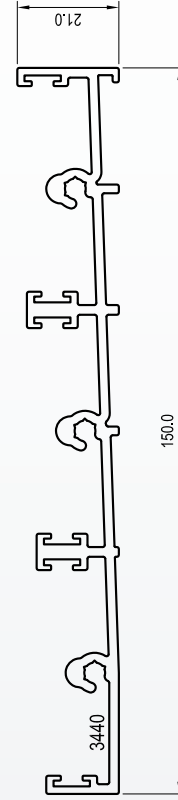

3440 SILL 3 TRACK LP WITH 3438 SILL PLANT-ON LP

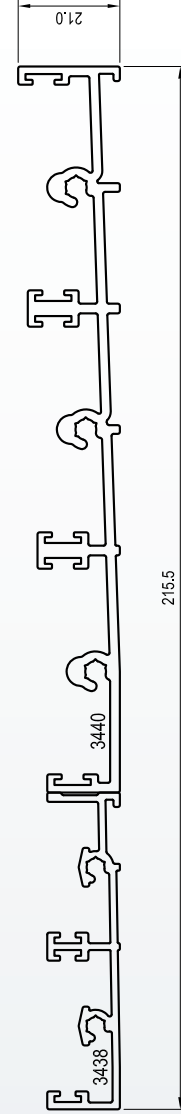

SILL REBATES

Note: Diagrams are not to scale

Commercial Corner Sliding Door 200

SILL 4 TRACK STD ASSEMBLY

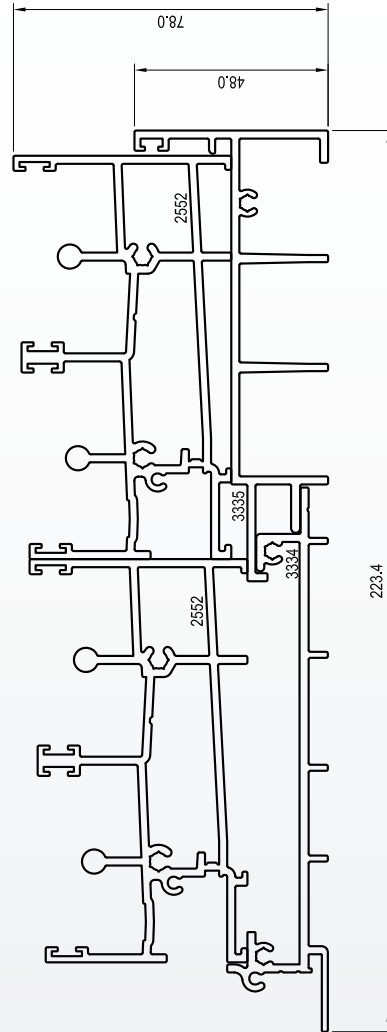

SILL 4 TRACK HP ASSEMBLY

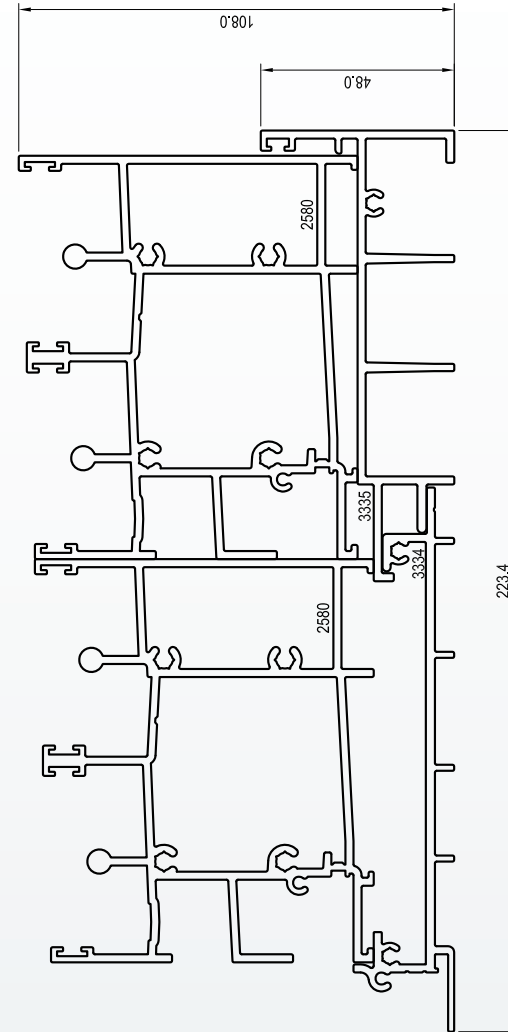

SILL REBATES

Note: Diagrams are not to scale

Commercial Corner Sliding Door 250

SILL 5 TRACK STD ASSEMBLY

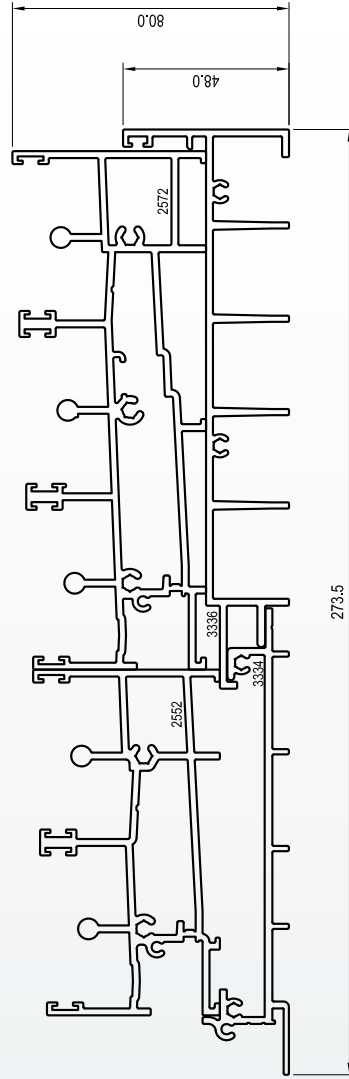

SILL 5 TRACK HP ASSEMBLY

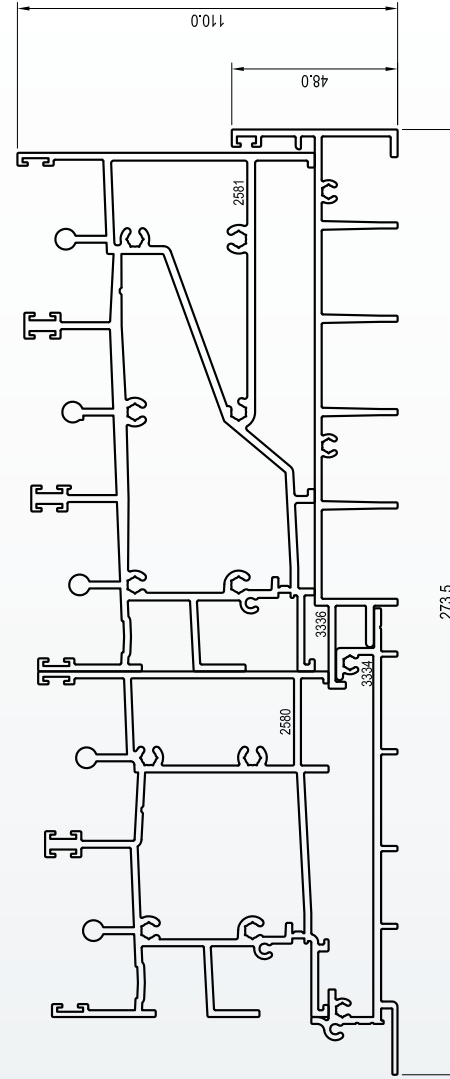

SILL REBATES

Note: Diagrams are not to scale

Commercial Corner Sliding Door 200

SILL 4 TRACK STD ASSEMBLY WITH 3370 SILL SCREEN & 3373 SUBSILL

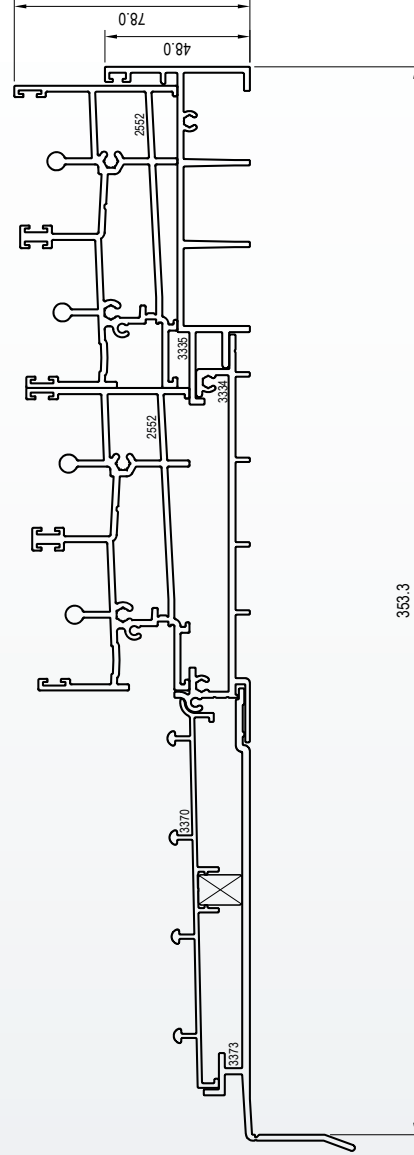

NOTE: REQUIRED PACKING TO BE SUPPLIED & FITTED BY BRADNAM'S OR LICENSEE.

SILL 4 TRACK HP ASSEMBLY WITH 3370 SILL SCREEN & 3373 SUBSILL

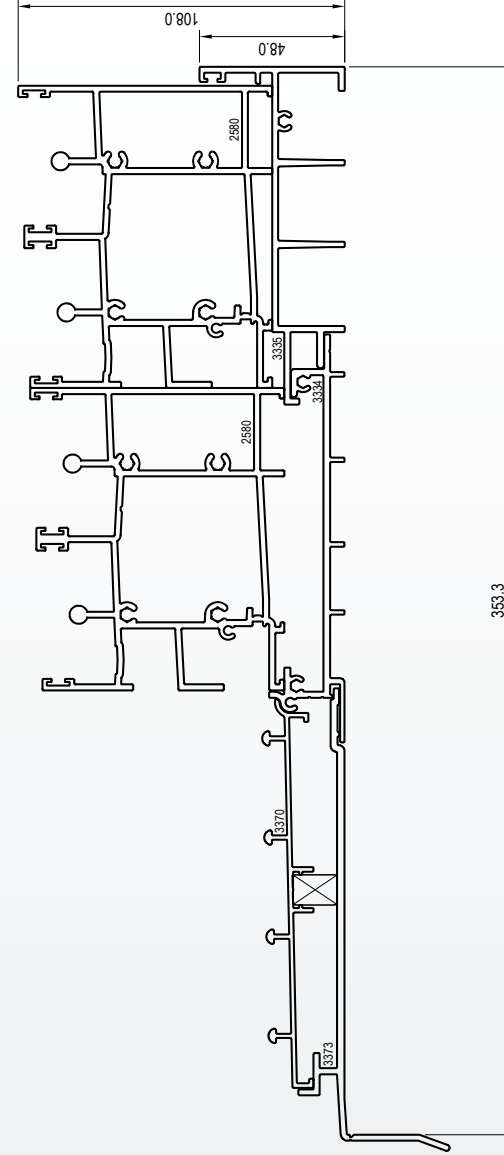

NOTE: REQUIRED PACKING TO BE SUPPLIED & FITTED BY BRADNAM'S OR LICENSEE.

SILL REBATES

Note: Diagrams are not to scale

Commercial Corner Sliding Door 250

SILL 5 TRACK STD ASSEMBLY WITH 3370 SILL SCREEN & 3373 SUBSILL

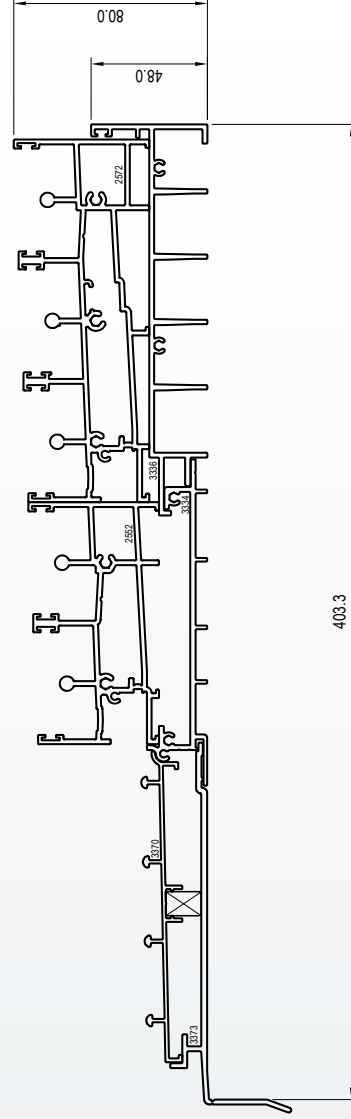

NOTE: REQUIRED PACKING TO BE SUPPLIED & FITTED BY BRADNAM'S OR LICENSEE.

SILL 5 TRACK HP ASSEMBLY WITH 3370 SILL SCREEN & 3373 SUBSILL

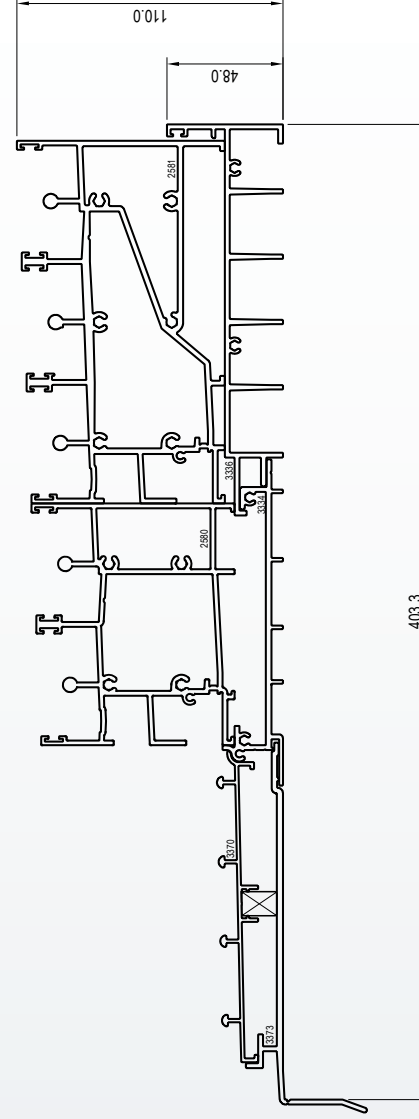

NOTE: REQUIRED PACKING TO BE SUPPLIED & FITTED BY BRADNAM'S OR LICENSEE.