



BRADNAM'S

# SLIDING DOORS

## PRODUCT INFORMATION

Product performance is subject to regional variations, design requirements and building codes. Performance parameters are independent of each other.

Images are for illustration purposes only and may not accurately represent the product. Bradnam's Windows & Doors reserves the right to change, alter or delete any aspect of this product without notice.



PERFORMANCE PARAMETERS

CONFIGURATIONS

STANDARD SIZES

COLONIAL BAR OPTIONS

PROFILE DIMENSIONS

REVEAL SETBACKS

SILL REBATES

# TABLE OF CONTENTS

---

<b>Performance Parameters</b>	3
<b>Configurations</b>	4
<b>Standard Sizes</b>	5
<b>Colonial Bar Options</b>	14
<b>Profile Dimensions</b>	15
<b>Reveal Setbacks</b>	18
<b>Sill Rebates</b>	
Essential	20
Signature	23
Commercial	38

---

## PERFORMANCE PARAMETERS

	Essential	Signature	Commercial
Frame sizes	80mm 140mm	100mm 166mm	100mm / 150mm 200mm / 250mm
Maximum door height	2450mm	2700mm	3100mm
Maximum door width	6246mm	6246mm	12000mm
Maximum panel width	1350mm	1350mm	1800mm
Maximum panel weight	50kg	100kg	160kg
Maximum water rating	300Pa	600Pa	650Pa
Maximum wind rating	3300Pa ULS	4500Pa ULS	6000Pa ULS
Maximum glass thickness (single glazed)	6.76mm	12.76mm	10.76mm
Maximum glass thickness (double glazed)	N/A	20mm	28mm
Maximum acoustic rating	Rw32	Rw44	Rw34
Maximum bushfire rating	BAL 40	BAL 40	BAL 40
Lowest U-value (single glazed)	3.5	4.2	4.5
Lowest U-value (double glazed)	N/A	2.7	3.1

**Note:** Performance figures are independent of each other and subject to conditions. Contact a Bradnam's Windows & Doors representative to discuss your specific project requirements.

# CONFIGURATIONS

## Standard

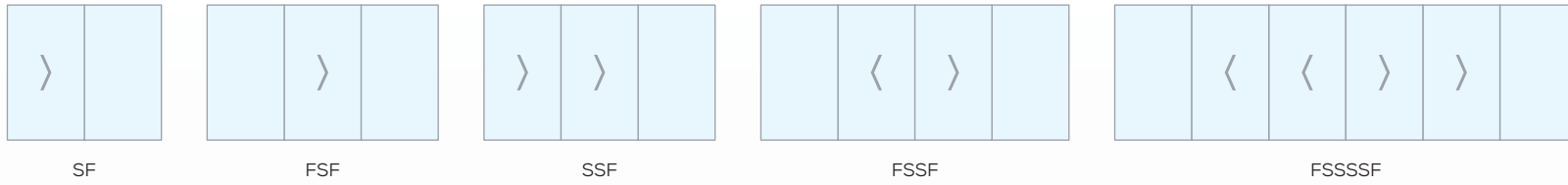



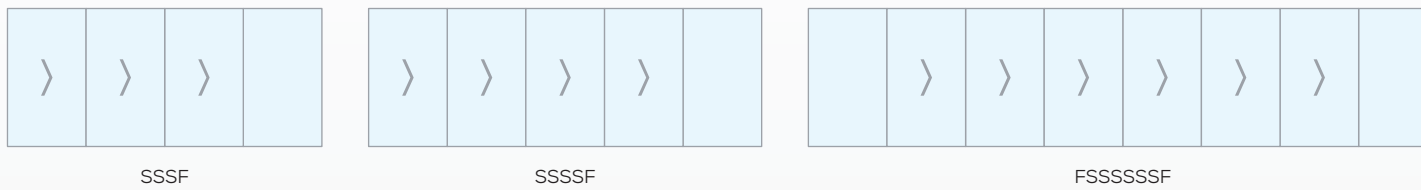









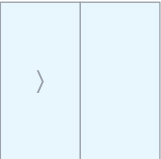





## Designer

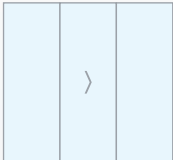

# STANDARD SIZES – QUEENSLAND

The availability of certain sizes and configurations is dependent on the design wind load requirement as per AS2047-2014. Check with your Bradnam's representative to confirm availability. Sliding Doors may be subject to local variation or regulatory requirements.

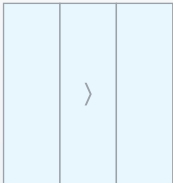
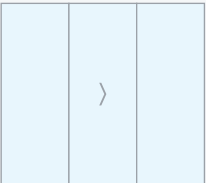
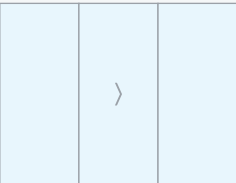
⊕ Available Single or Double Glazed (Signature & Commercial versions only)

STUD OPENING mm		1560	1860	2160	2460	2760	
FRAME SIZE mm		1510	1810	2110	2410	2710	
2130	2100						Also available in FS configuration 
		SF2115	SF2118	SF2121	SF2124	SF2127	
2430	2400						
		SF2415	SF2418	SF2421	SF2424	SF2427	
STUD OPENING mm		2288	2738	3188	3638	4088	
FRAME SIZE mm		2238	2688	3138	3588	4038	
2130	2100						Also available in FSFL configuration 
		FSFR2122	FSFR2127	FSFR2131	FSFR2136	FSFR2140	
2430	2400						
		FSFR2422	FSFR2427	FSFR2431	FSFR2436	FSFR2440	

Viewed from exterior: S = Sliding Panel, F = Fixed Panel

# STANDARD SIZES – QUEENSLAND

The availability of certain sizes and configurations is dependent on the design wind load requirement as per AS2047-2014. Check with your Bradnam's representative to confirm availability. Sliding Doors may be subject to local variation or regulatory requirements.

⊕ Available Single or Double Glazed (Signature & Commercial versions only)

STUD OPENING mm		2288	2738	3188	3638	4088	
FRAME SIZE mm		2238	2688	3138	3588	4038	
2130	2100						Also available in FSS configuration 
	2400						
STUD OPENING mm		3034	3634	4234	4834	5434	
FRAME SIZE mm		2984	3584	4184	4784	5384	
2130	2100						
	2400						

# STANDARD SIZES – QUEENSLAND

The availability of certain sizes and configurations is dependent on the design wind load requirement as per AS2047-2014. Check with your Bradnam's representative to confirm availability. Sliding Doors may be subject to local variation or regulatory requirements.

⊕ Available Single or Double Glazed (Signature & Commercial versions only)













STUD OPENING mm		4496	5396	6296
FRAME SIZE mm		4446	5346	6246
2130	2100			
		FSSSSF2144	FSSSSF2153	FSSSSF2162
2430	2400			
		FSSSSF2444	FSSSSF2453	FSSSSF2462

Viewed from exterior: **S** = Sliding Panel, **F** = Fixed Panel

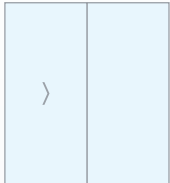
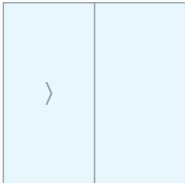
# STANDARD SIZES – NEW SOUTH WALES

The availability of certain sizes and configurations is dependent on the design wind load requirement as per AS2047-2014. Check with your Bradnam's representative to confirm availability. Sliding Doors may be subject to local variation or regulatory requirements.

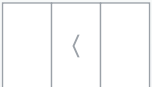
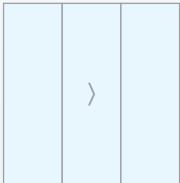
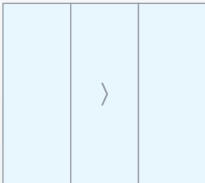
⊕ Available Single or Double Glazed (Signature & Commercial versions only)

STUD OPENING mm		1630	1870	2230	2470	
FRAME SIZE mm		1570	1810	2170	2410	
2130	2100					Also available in FS configuration 
		SF2116	SF2118	SF2122	SF2124	
2430	2400					
		SF2416	SF2418	SF2422	SF2424	
STUD OPENING mm		2388	2748	3288	3648	
FRAME SIZE mm		2328	2688	3228	3588	
2130	2100					Also available in FSFL configuration 
		FSF2123	FSF2127	FSF2132	FSF2136	
2430	2400					
		FSF2423	FSF2427	FSF2432	FSF2436	



Viewed from exterior: S = Sliding Panel, F = Fixed Panel



# STANDARD SIZES – NEW SOUTH WALES

The availability of certain sizes and configurations is dependent on the design wind load requirement as per AS2047-2014. Check with your Bradnam's representative to confirm availability. Sliding Doors may be subject to local variation or regulatory requirements.

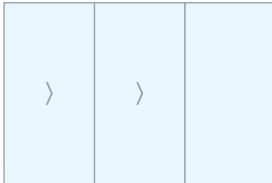
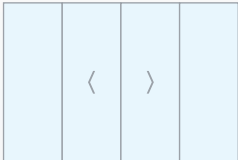
⊕ Available Single or Double Glazed (Signature & Commercial versions only)

STUD OPENING mm		2388	2748	3288	3648
FRAME SIZE mm		2328	2688	3228	3588
2130	2100				
		SSF2123	SSF2127	SSF2132	SSF2136
2430	2400				
		SSF2423	SSF2427	SSF2432	SSF2436
STUD OPENING mm		3164	3644	4364	4844
FRAME SIZE mm		3104	3584	4304	4784
2130	2100				
		FSSF2131	FSSF2136	FSSF2143	FSSF2148
2430	2400				
		FSSF2431	FSSF2436	FSSF2443	FSSF2448

Also available in FSS configuration



# STANDARD SIZES – NEW SOUTH WALES

The availability of certain sizes and configurations is dependent on the design wind load requirement as per AS2047-2014. Check with your Bradnam's representative to confirm availability. Sliding Doors may be subject to local variation or regulatory requirements.













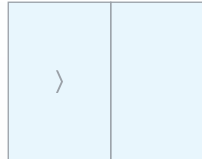

⊕ Available Single or Double Glazed (Signature & Commercial versions only)

STUD OPENING mm		4686	5406	6306
FRAME SIZE mm		4626	5346	6246
2130	2100			
		FSSSSF2146	FSSSSF2153	FSSSSF2162
2430	2400			
		FSSSSF2446	FSSSSF2453	FSSSSF2462

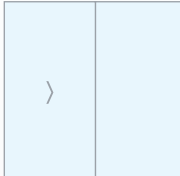
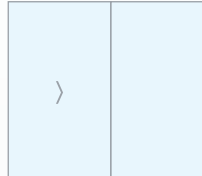
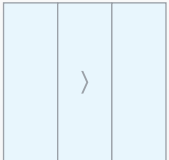
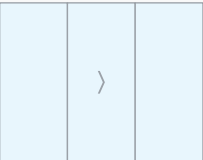
Viewed from exterior: **S** = Sliding Panel, **F** = Fixed Panel

# STANDARD SIZES – VICTORIA

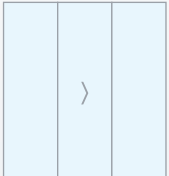
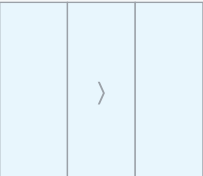
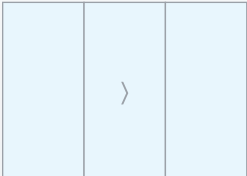
The availability of certain sizes and configurations is dependent on the design wind load requirement as per AS2047-2014. Check with your Bradnam's representative to confirm availability. Sliding Doors may be subject to local variation or regulatory requirements.

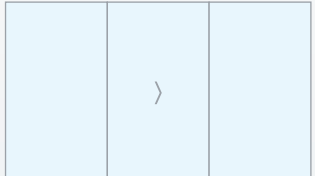
STUD OPENING mm		1510	1870	2230	2470	2770	
FRAME SIZE mm		1450	1810	2170	2410	2710	
2130	2100						Also available in FS configuration 
		SF2115	SF2118	SF2122	SF2124	SF2127	
2430	2400						
		SF2415	SF2418	SF2421	SF2424	SF2427	
STUD OPENING mm		2208	2748	3288	3648	4098	
FRAME SIZE mm		2148	2688	3228	3588	4038	
2130	2100						Also available in FSFL configuration 
		FSFR2122	FSFR2127	FSFR2132	FSFR2136	FSFR2140	
2430	2400						
		FSFR2422	FSFR2427	FSFR2432	FSFR2436	FSFR2440	

Viewed from exterior: S = Sliding Panel, F = Fixed Panel

# STANDARD SIZES – VICTORIA

The availability of certain sizes and configurations is dependent on the design wind load requirement as per AS2047-2014. Check with your Bradnam's representative to confirm availability. Sliding Doors may be subject to local variation or regulatory requirements.

STUD OPENING mm		2208	2748	3288	3648	4098	
FRAME SIZE mm		2148	2688	3228	3588	4038	
2130	2100						Also available in FSS configuration 
		SSF2122	SSF2127	SSF2132	SSF2136	SSF2140	
2430	2400						
		SSF2422	SSF2427	SSF2432	SSF2436	SSF2440	
STUD OPENING mm		2924	3644	4364	4844	5444	
FRAME SIZE mm		2864	3584	4304	4784	5384	
2130	2100						
		FSSF2129	FSSF2136	FSSF2143	FSSF2148	FSSF2154	
2430	2400						
		FSSF2429	FSSF2436	FSSF2443	FSSF2448	FSSF2454	

# STANDARD SIZES – VICTORIA

The availability of certain sizes and configurations is dependent on the design wind load requirement as per AS2047-2014. Check with your Bradnam's representative to confirm availability. Sliding Doors may be subject to local variation or regulatory requirements.

STUD OPENING mm		4326	5406	6306
FRAME SIZE mm		4266	5346	6246
2130	2100			
		FSSSSF2143	FSSSSF2153	FSSSSF2162
2430	2400			
		FSSSSF2443	FSSSSF2453	FSSSSF2462

Viewed from exterior: **S** = Sliding Panel, **F** = Fixed Panel

# COLONIAL BAR OPTIONS

## Design Options

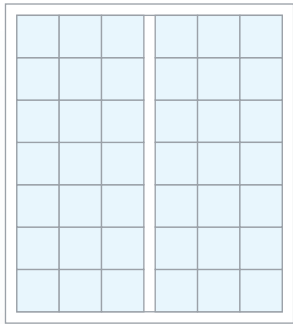

SF2118  
Traditional Colonial

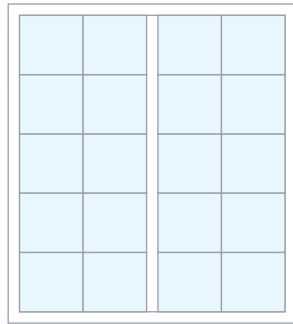

SF2118  
Australian Colonial

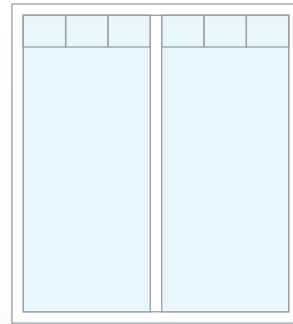

SF2118  
Highlander



SF2118  
Traditional Federation

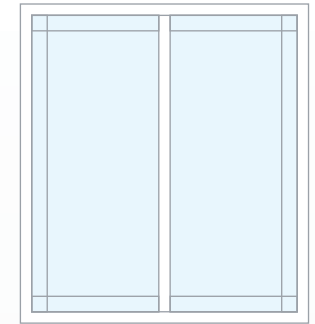

SF2118  
Australian Federation

## Types of Colonial Bar

Scale 5:1

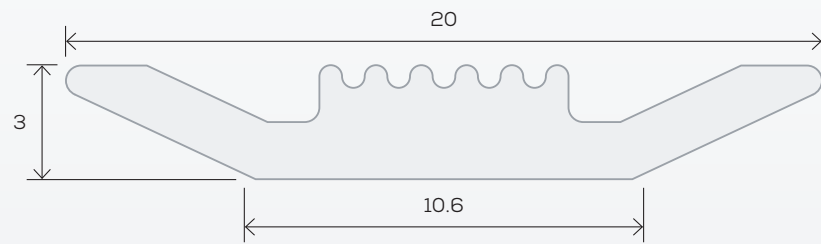

Raised



Flat

Raised bar cannot be fitted on essential sliding doors

# PROFILE DIMENSIONS

Note: Diagrams are not to scale. They are illustrations only, and may not accurately represent the product. Their purpose is to show the profile dimensions.

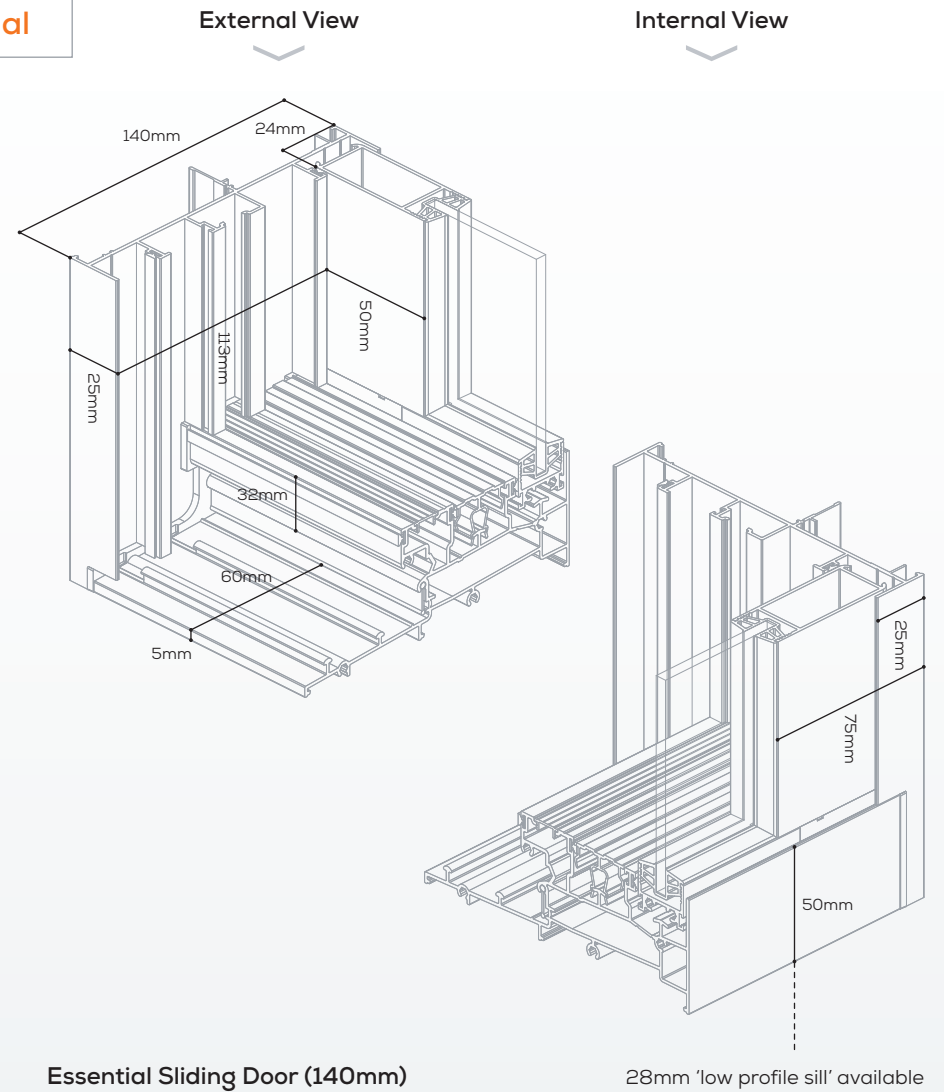
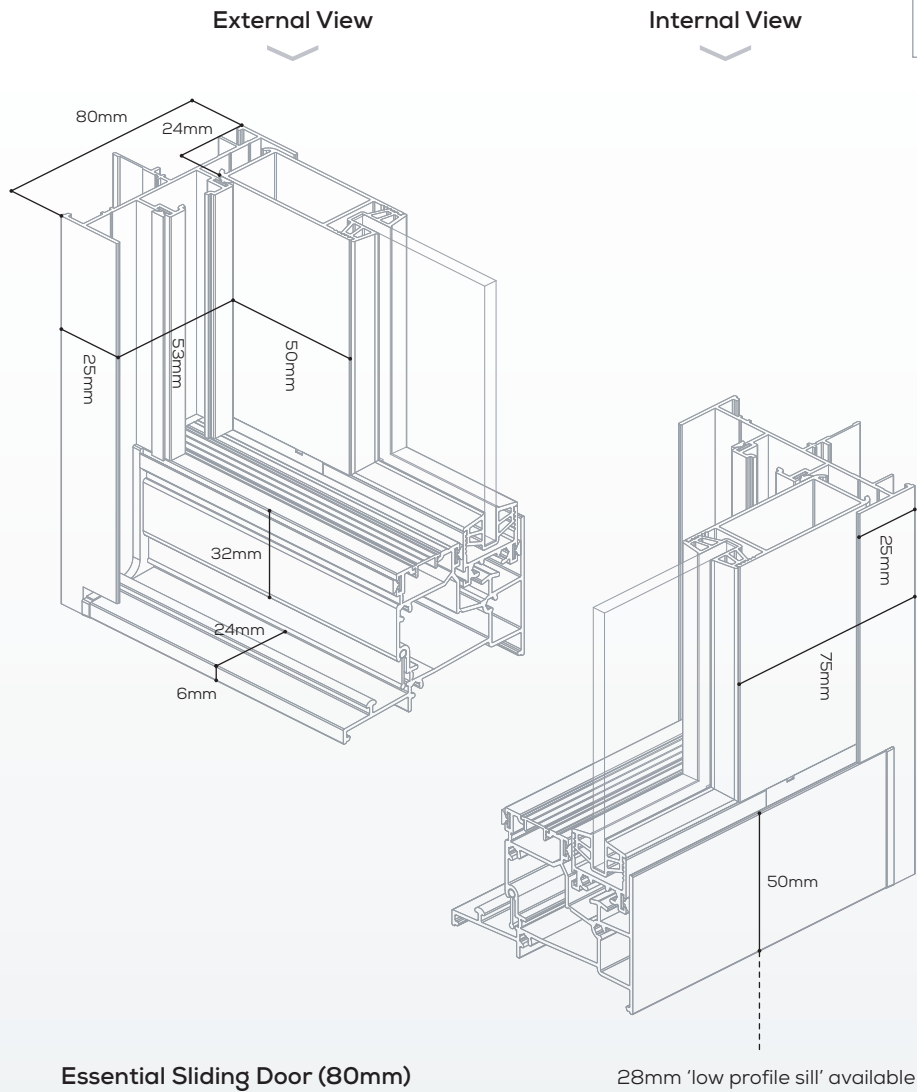

# PROFILE DIMENSIONS

Note: Diagrams are not to scale. They are illustrations only, and may not accurately represent the product. Their purpose is to show the profile dimensions.

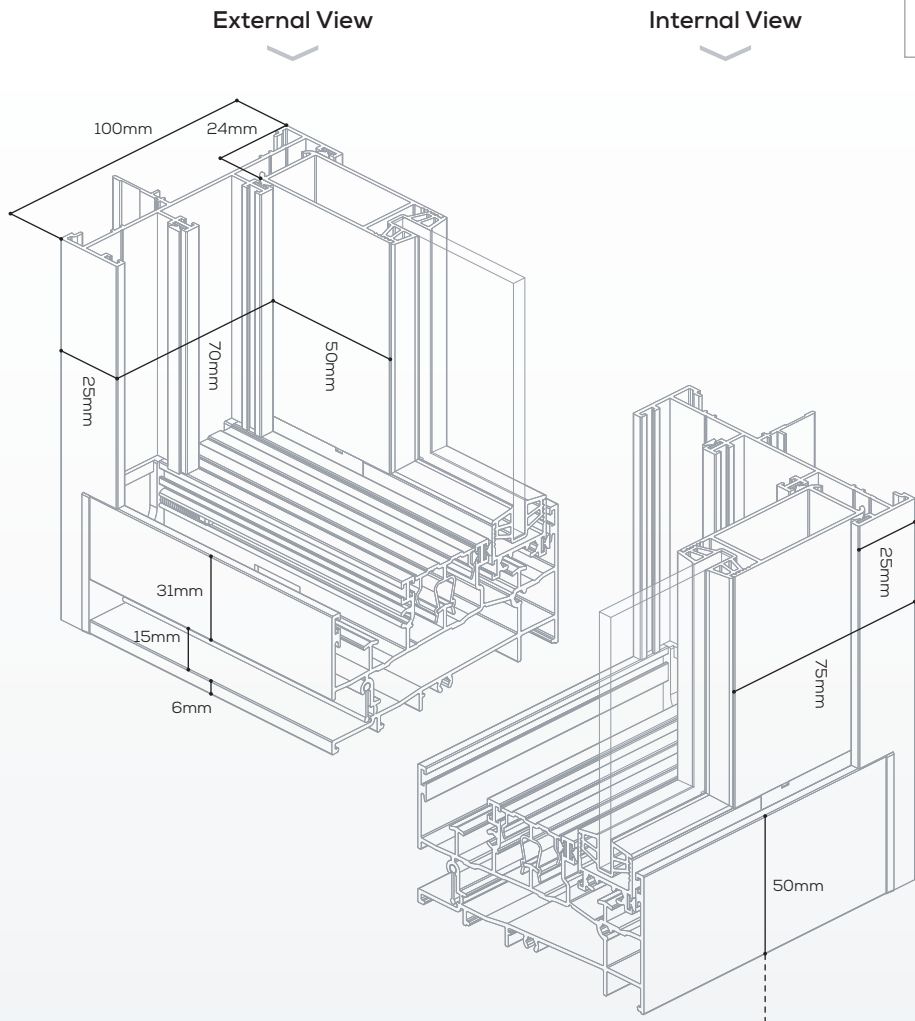

Signature Sliding Door (100mm)

80mm '600 pascal sill' available  
17mm and 32mm 'low profile sill' available

## Signature

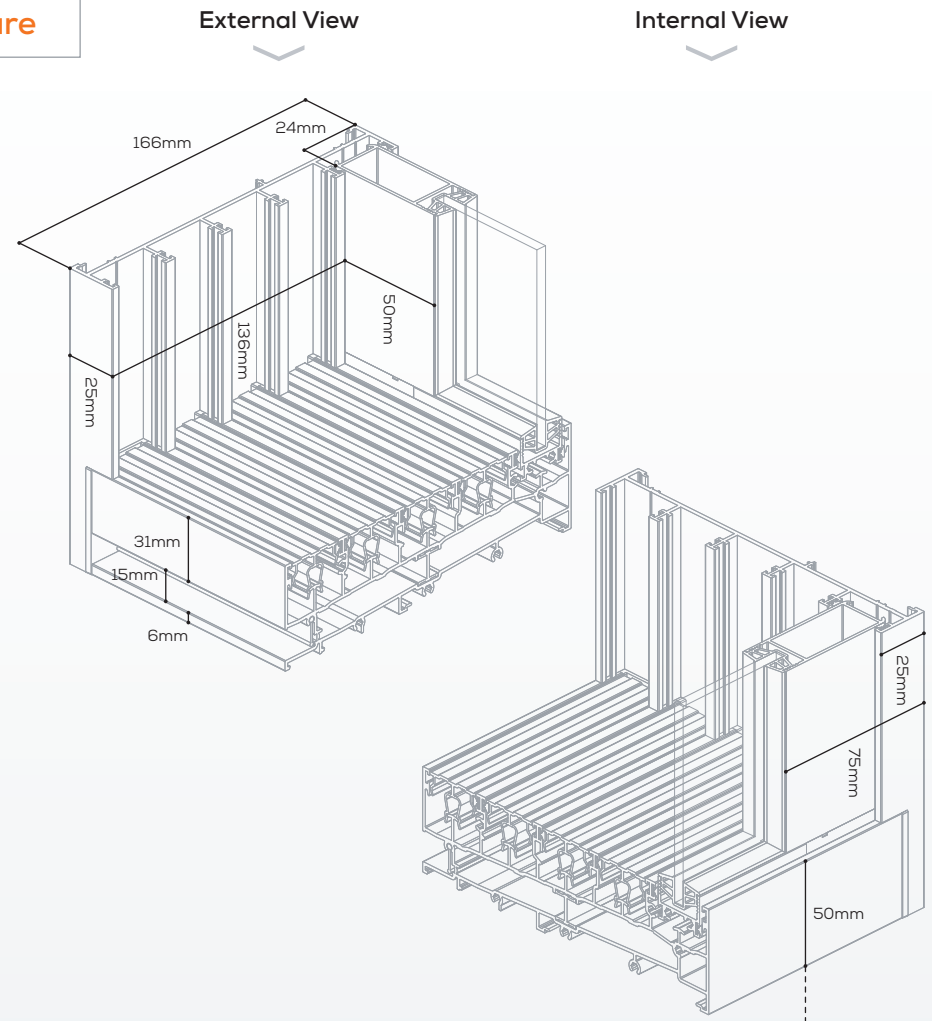

Signature Sliding Door (166mm)

80mm '600 pascal sill' available  
17mm and 32mm 'low profile sill' available



# PROFILE DIMENSIONS

Note: Diagrams are not to scale. They are illustrations only, and may not accurately represent the product. Their purpose is to show the profile dimensions.

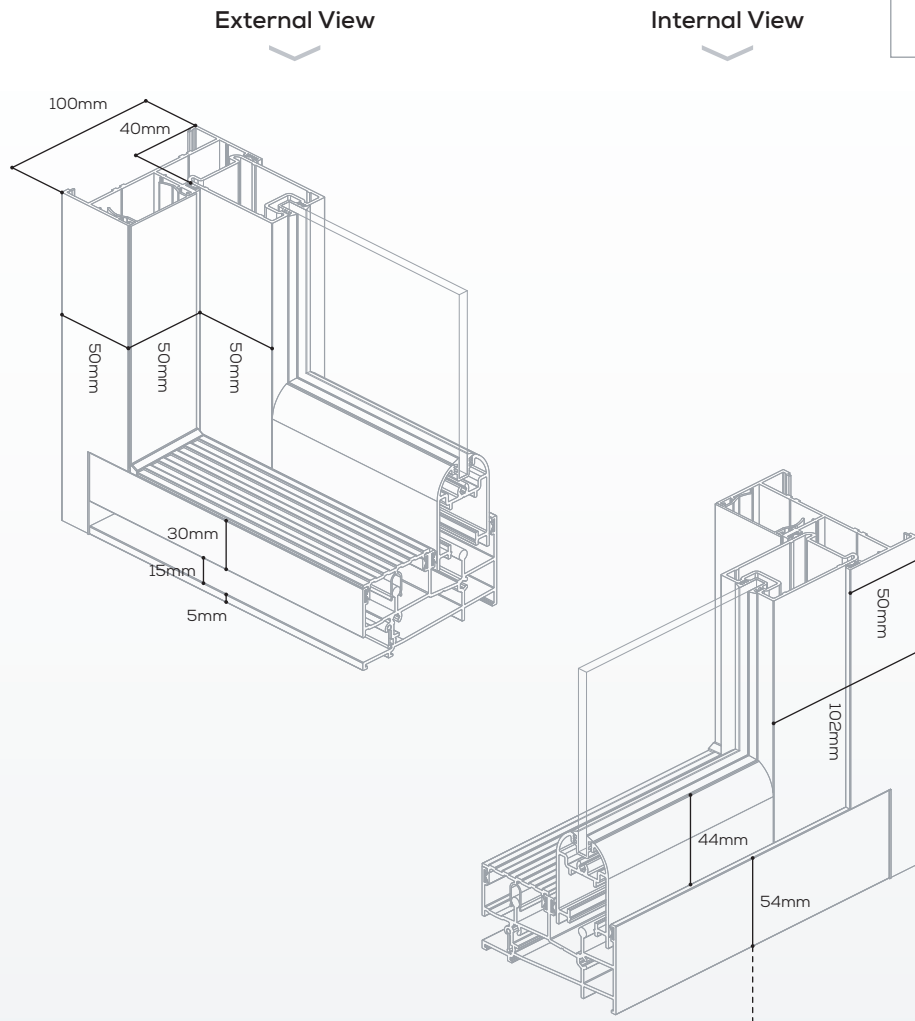

**Commercial Sliding Door (100mm)**

84mm '600 pascal sill' available  
19mm 'low profile sill' available

## Commercial

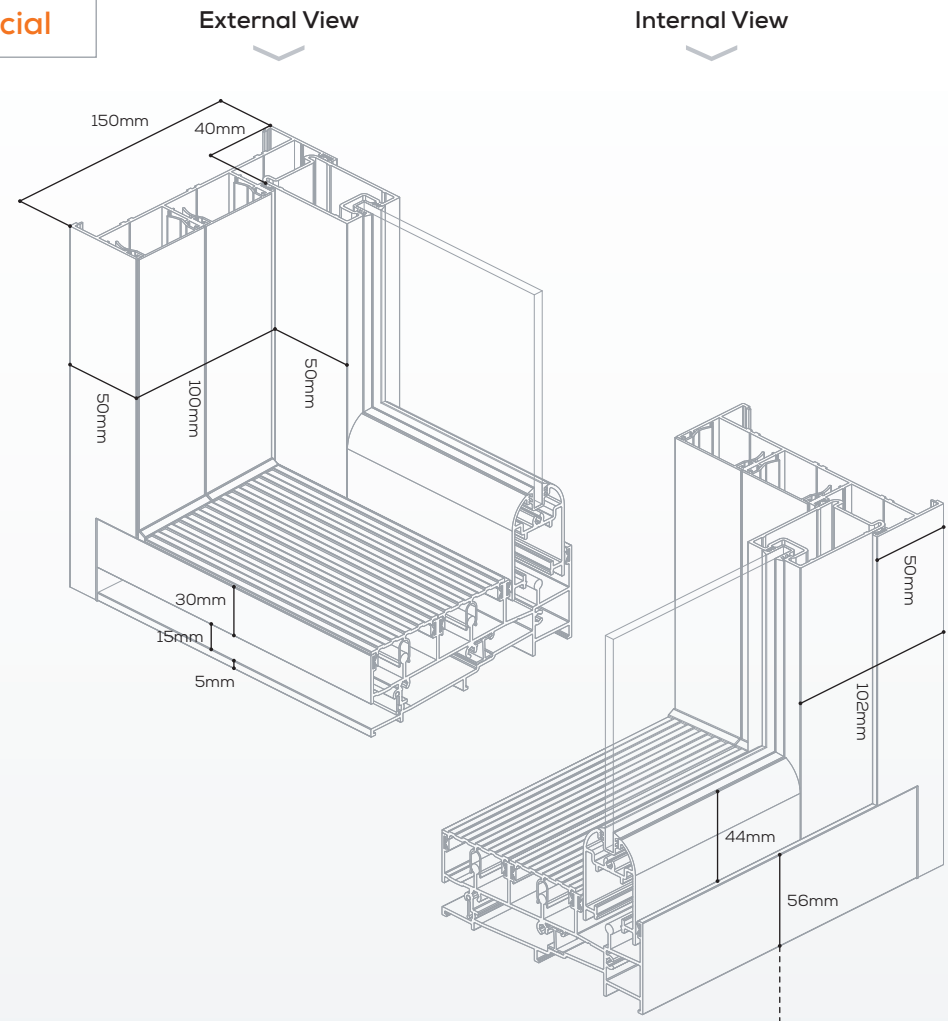

**Commercial Sliding Door (150mm)**

86mm '600 pascal sill' available  
21mm 'low profile sill' available

# REVEAL SETBACKS

Note: Diagrams are not to scale

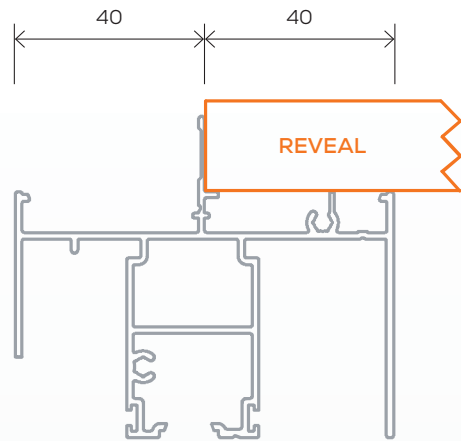

Essential Sliding Door (80mm)

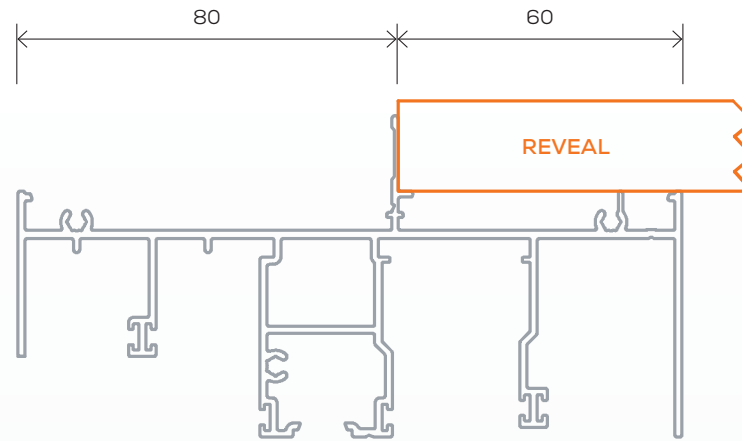

Essential Sliding Door (140mm)

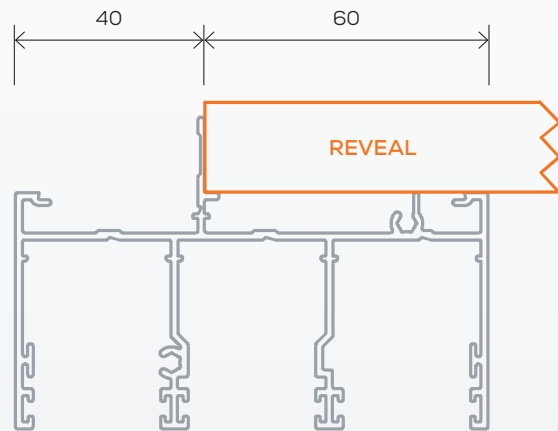

Signature Sliding Door (100mm)

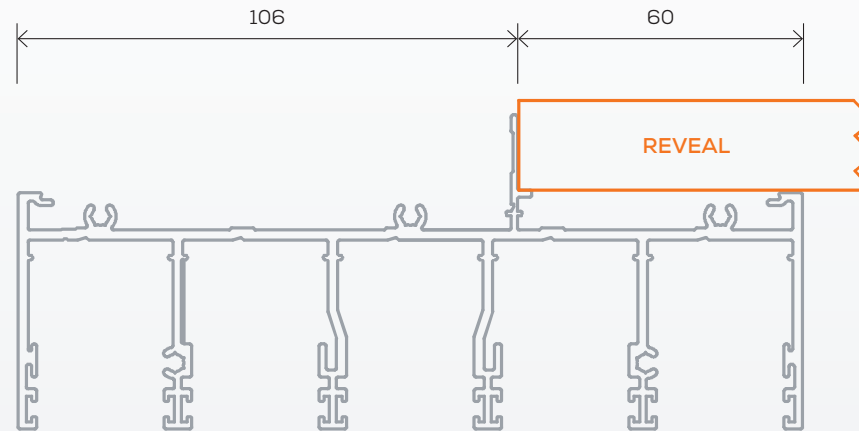

Signature Sliding Door (166mm)

# REVEAL SETBACKS

Note: Diagrams are not to scale

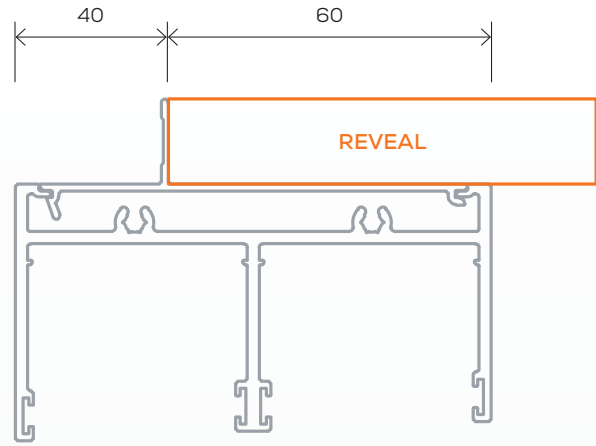

Commercial Sliding Door (100mm)

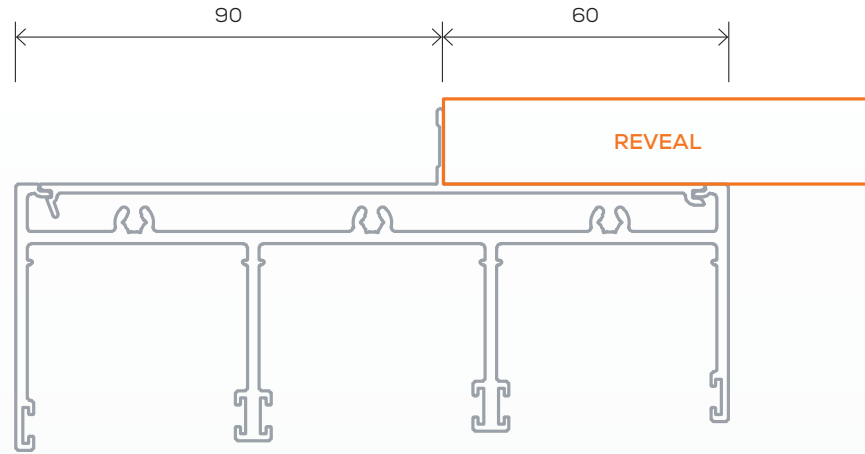

Commercial Sliding Door (150mm)

# SILL REBATES

Note: Diagrams are not to scale

## Essential Sliding Door 80

3040 SILL STD 80

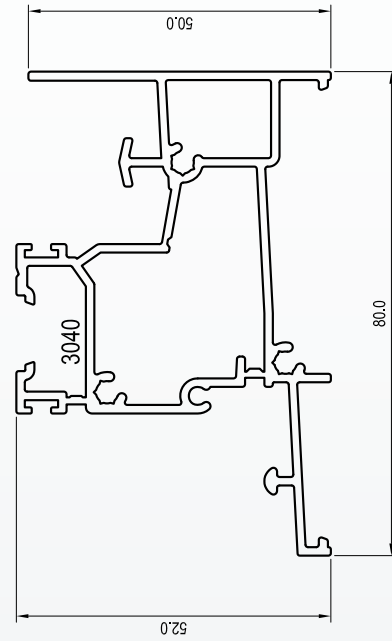

3040 SILL STD 80 WITH 3348 SUBSILL '15' 80

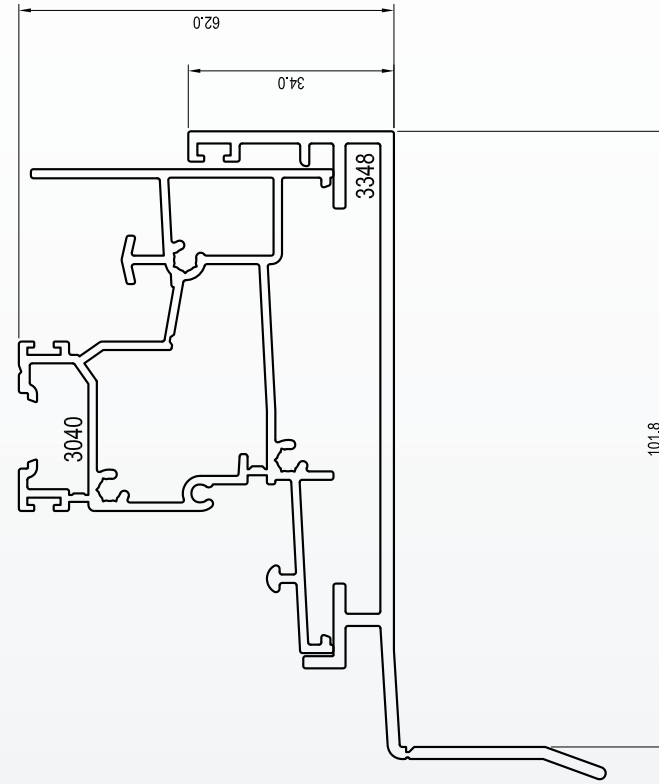

# SILL REBATES

Note: Diagrams are not to scale

## Essential Sliding Door 80

3048 SILL LP 80

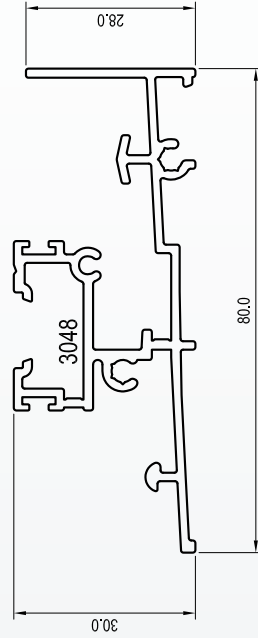

3048 SILL LP 80 WITH 3348 SUBSILL '15' 80

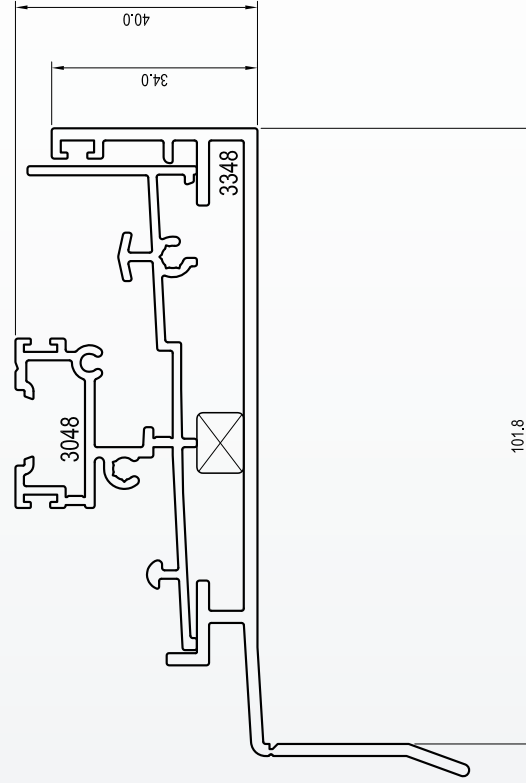

NOTE: REQUIRED PACKING TO BE SUPPLIED & FITTED BY BRADNAM'S OR LICENSEE.

# SILL REBATES

Note: Diagrams are not to scale

## Essential Sliding Door 140

3041 SILL STACKER

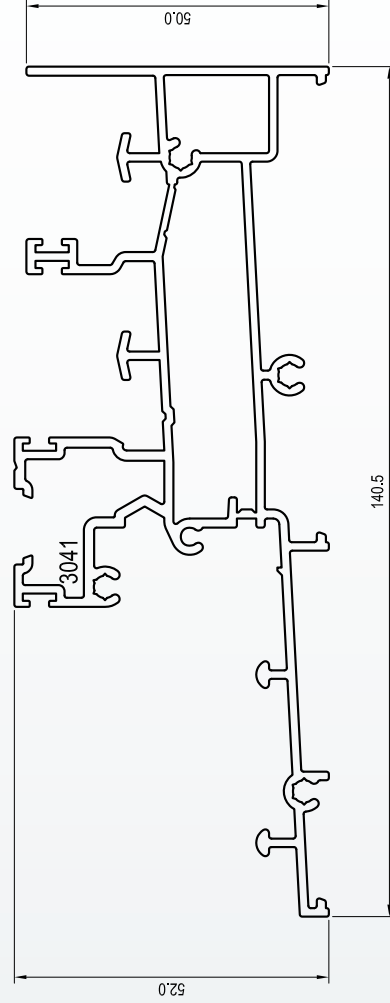

3041 SILL STACKER WITH 3350 SUBSILL '15' 140

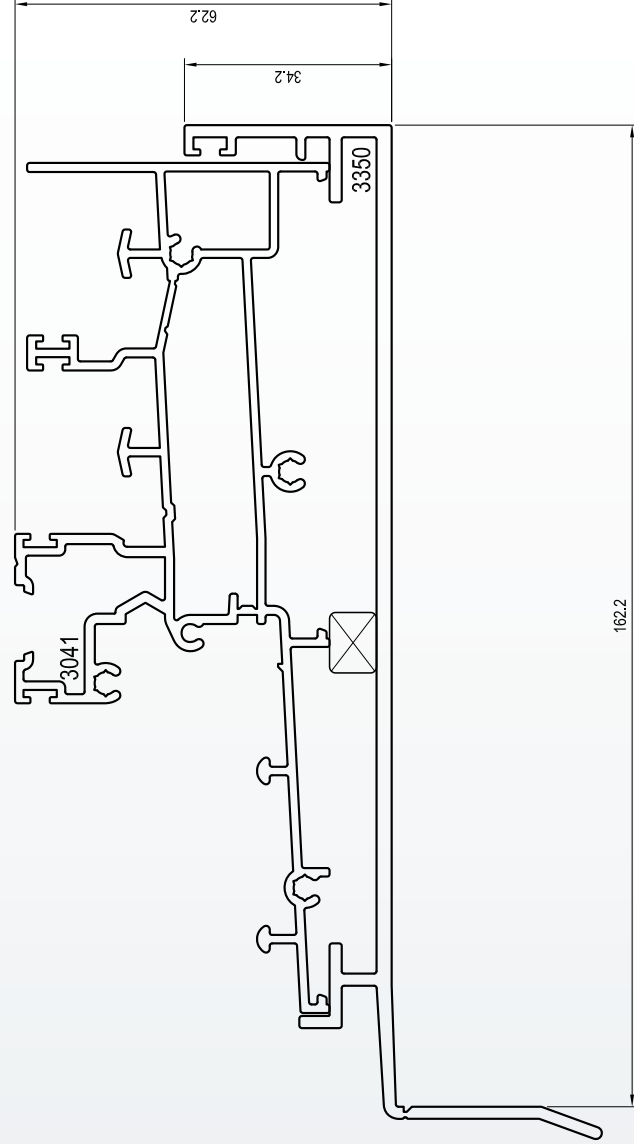

NOTE: REQUIRED PACKING TO BE SUPPLIED & FITTED BY BRADNAM'S OR LICENSEE.

# SILL REBATES

Note: Diagrams are not to scale

## Signature Sliding Door 100

3001 SILL 3 TRACK

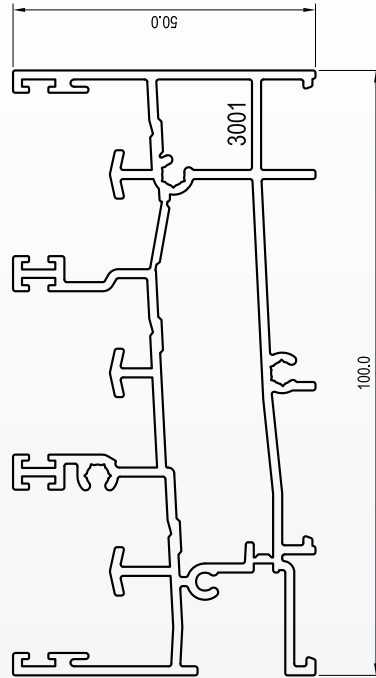

3001 SILL 3 TRACK WITH 3353 SUBSILL '15' 100

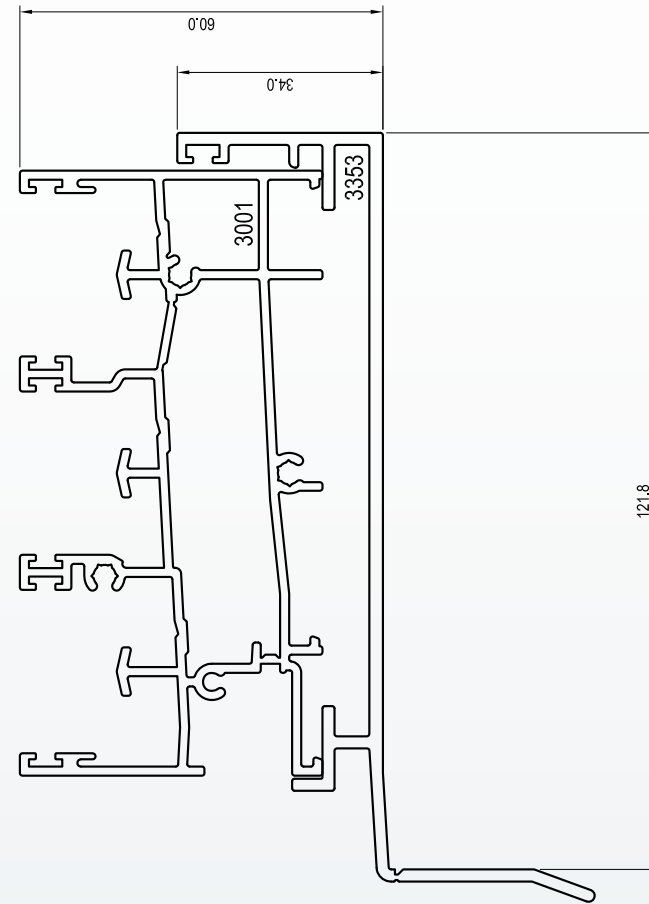

# SILL REBATES

Note: Diagrams are not to scale

## Signature Sliding Door 100

3001 SILL 3 TRACK WITH 2876 SUBSILL '35' 100

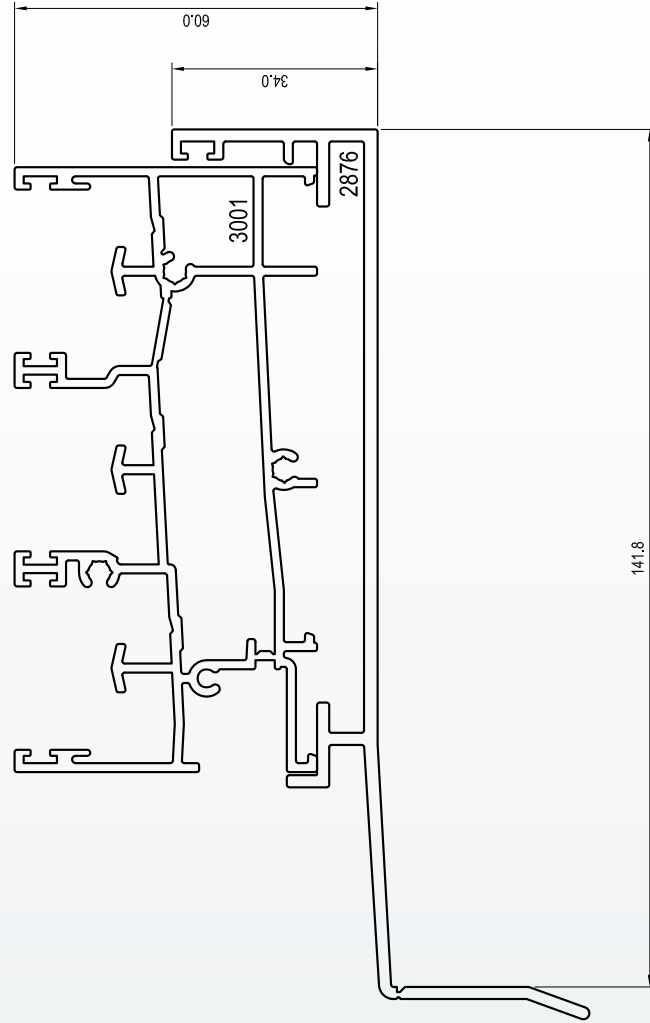

3001 SILL 3 TRACK WITH 3017 SUBSILL BAFFLED 100

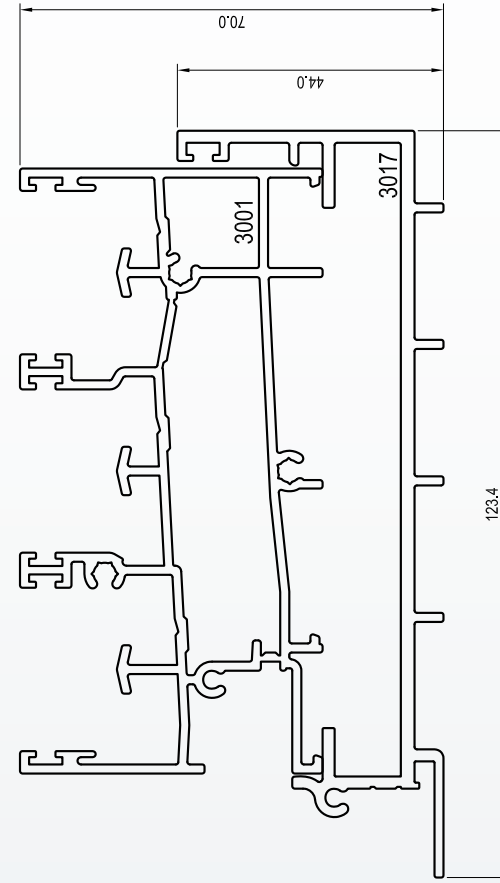



# SILL REBATES

Note: Diagrams are not to scale

## Signature Sliding Door 100

3012 SILL 3 TRACK 600Pa

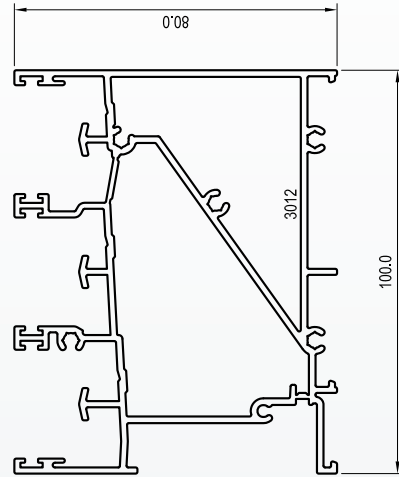

3012 SILL 3 TRACK 600Pa WITH 3353 SUBSILL '15' 100

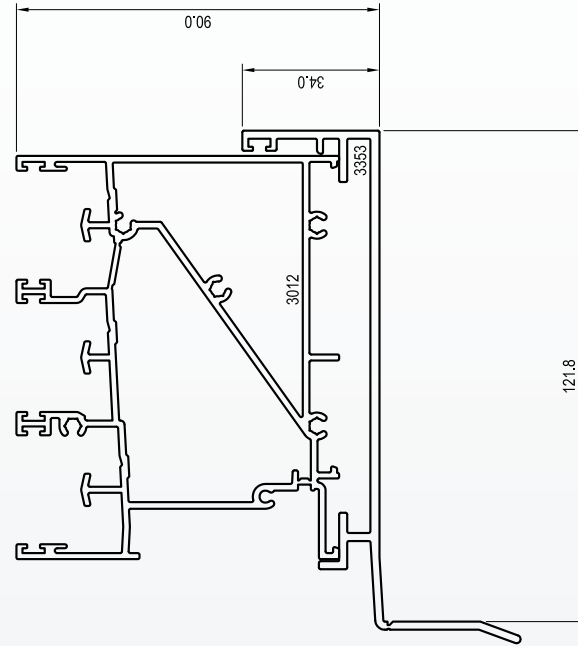

# SILL REBATES

Note: Diagrams are not to scale

## Signature Sliding Door 100

3012 SILL 3 TRACK 600Pa WITH 2876 SUBSILL '35' 100

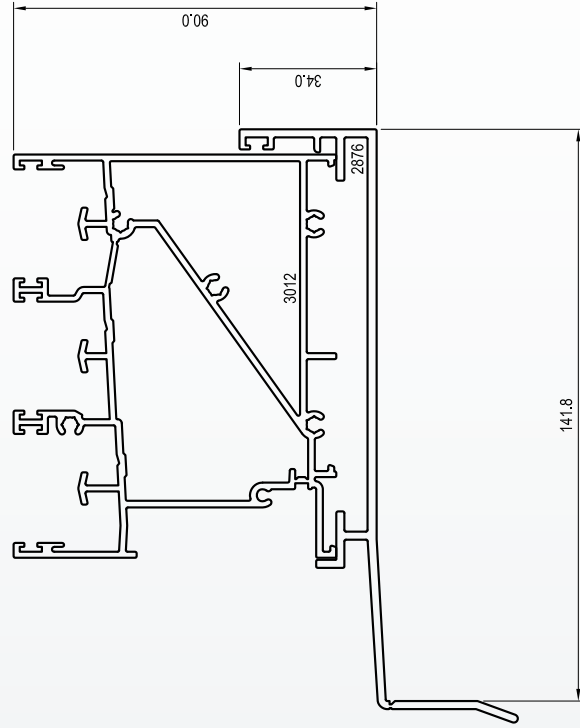

3012 SILL 3 TRACK 600Pa WITH 3017 SUBSILL BAFFLED 100

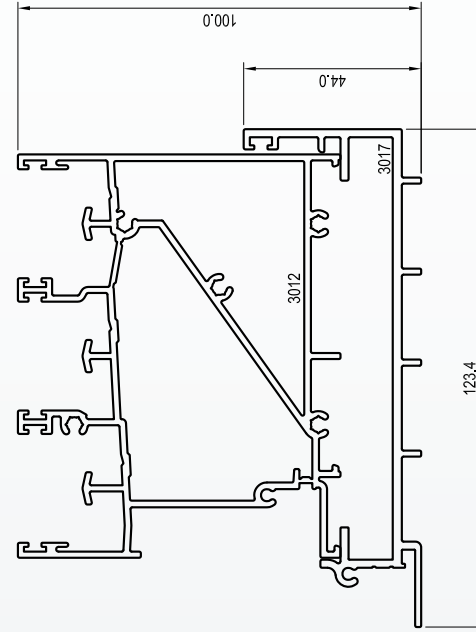

# SILL REBATES

Note: Diagrams are not to scale

## Signature Sliding Door 100

3434 SILL 100 LP 17

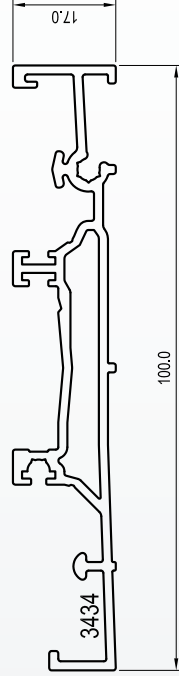

3430 SILL 100 LP 32

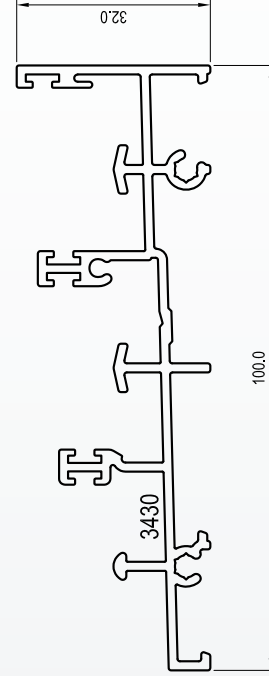

3430 SILL 100 LP 32 WITH 3353 SUBSILL '15' 100

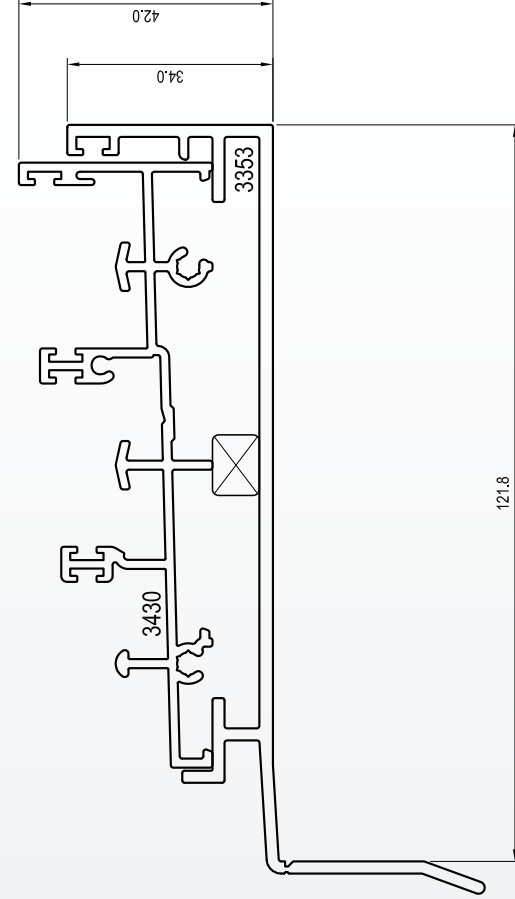

NOTE: REQUIRED PACKING TO BE SUPPLIED & FITTED BY BRADNAM'S OR LICENSEE.

# SILL REBATES

Note: Diagrams are not to scale

## Signature Sliding Door 100

3430 SILL 100 LP 32 WITH 2876 SUBSILL '35' 100

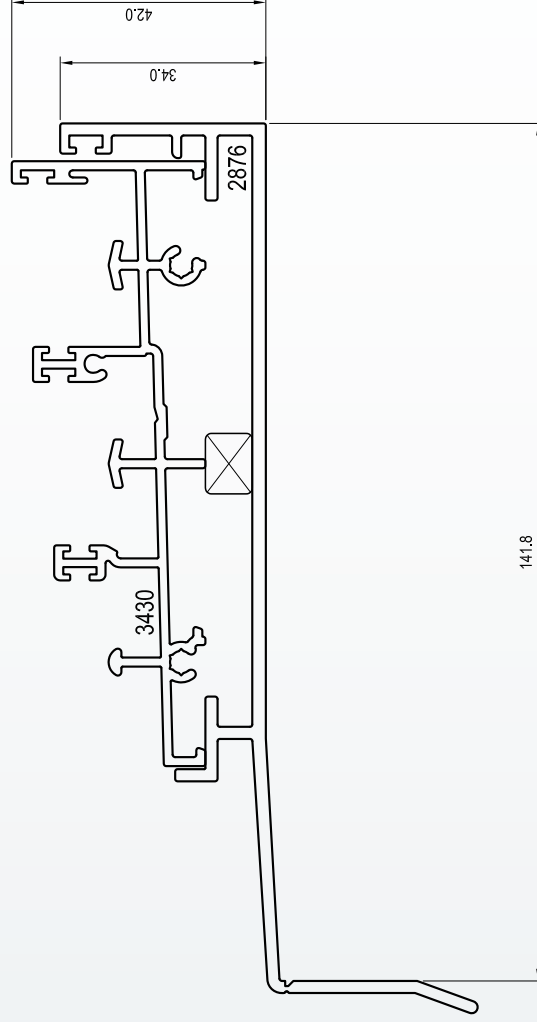

NOTE: REQUIRED PACKING TO BE SUPPLIED & FITTED BY BRADNAM'S OR LICENSEE.

3430 SILL 100 LP 32 WITH 3017 SUBSILL BAFFLED 100

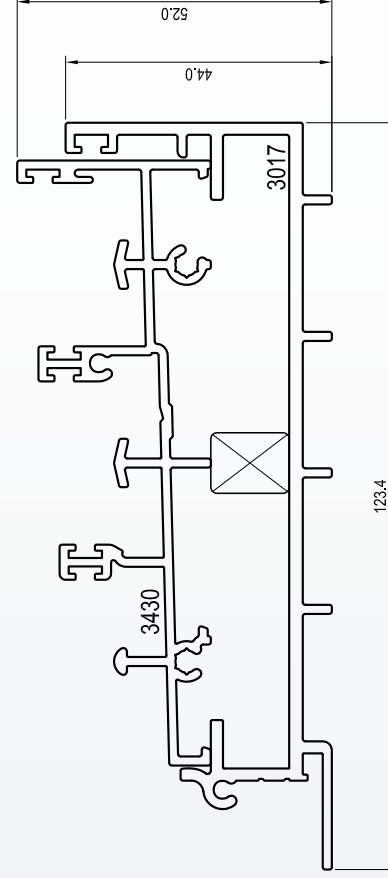

NOTE: REQUIRED PACKING TO BE SUPPLIED & FITTED BY BRADNAM'S OR LICENSEE.

# SILL REBATES

Note: Diagrams are not to scale

## Signature Sliding Door 100

3001 SILL 3 TRACK & 3038 SILL PLANT-ON

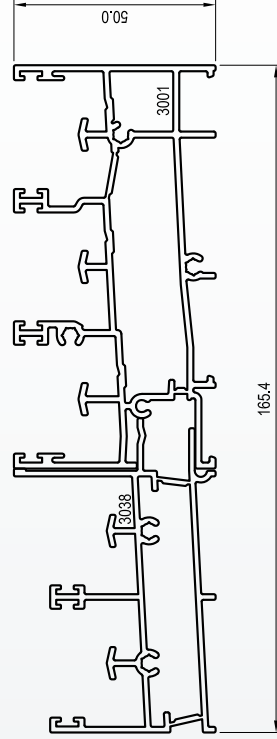

3001 SILL 3 TRACK & 3038 SILL PLANT-ON WITH 3349 SUBSILL '15' 166

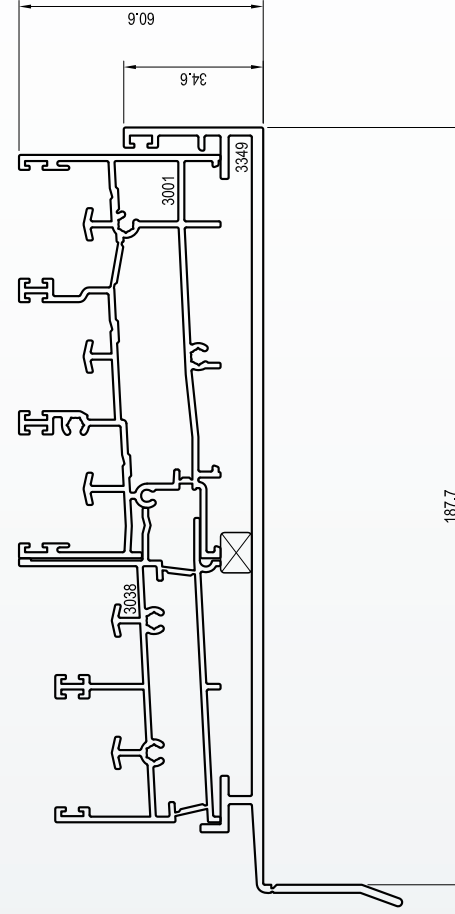

NOTE: REQUIRED PACKING TO BE SUPPLIED & FITTED BY BRADNAM'S OR LICENSEE.

# SILL REBATES

Note: Diagrams are not to scale

## Signature Sliding Door 100

3001 SILL 3 TRACK & 3038 SILL PLANT-ON WITH 3374 SUBSILL BAFFLED 166

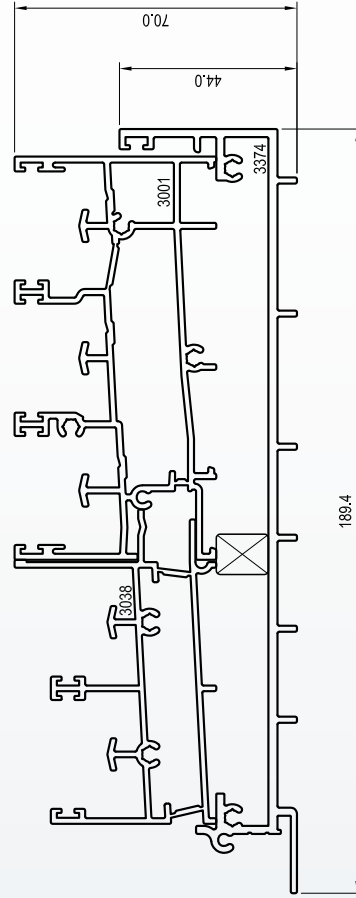

NOTE: REQUIRED PACKING TO BE SUPPLIED & FITTED BY BRADNAM'S OR LICENSEE.

3001 SILL 3 TRACK & 3038 SILL PLANT-ON WITH 3335 & 3337 SUBSILLS

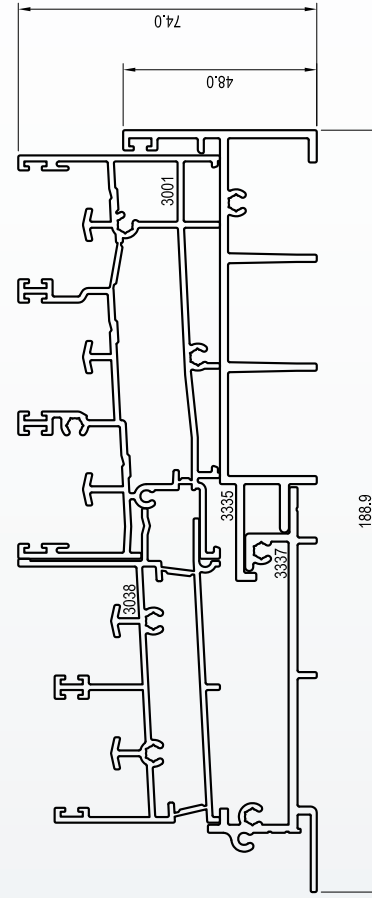

# SILL REBATES

Note: Diagrams are not to scale

## Signature Sliding Door 100

3012 SILL 3 TRACK 600Pa & 3038 SILL PLANT-ON

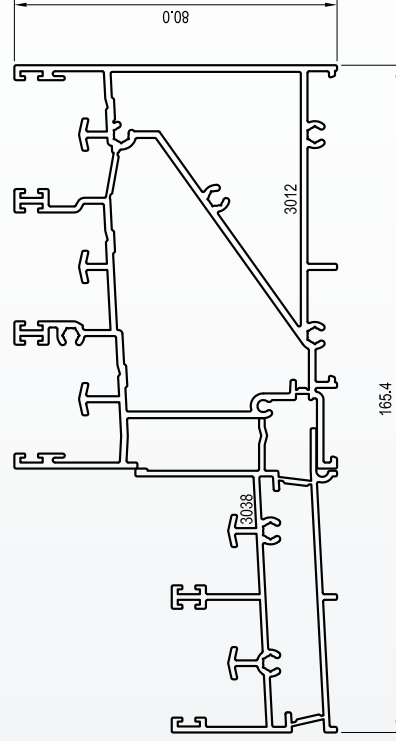

3012 SILL 3 TRACK 600Pa & 3038 SILL PLANT-ON WITH 3349 SUBSILL '15' 166

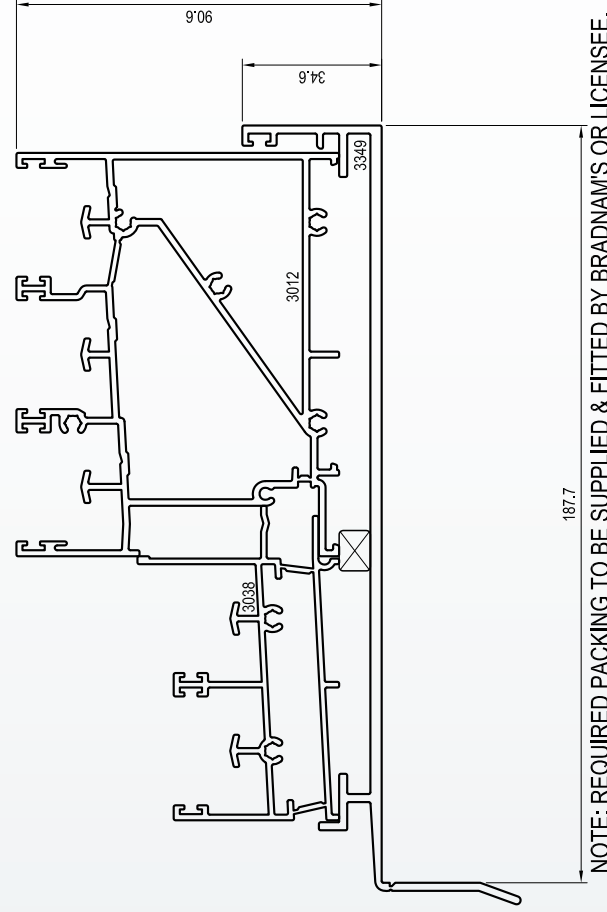

# SILL REBATES

Note: Diagrams are not to scale

## Signature Sliding Door 100

3012 SILL 3 TRACK 600Pa & 3038 SILL PLANT-ON WITH 3374 SUBSILL BAFFLED 166

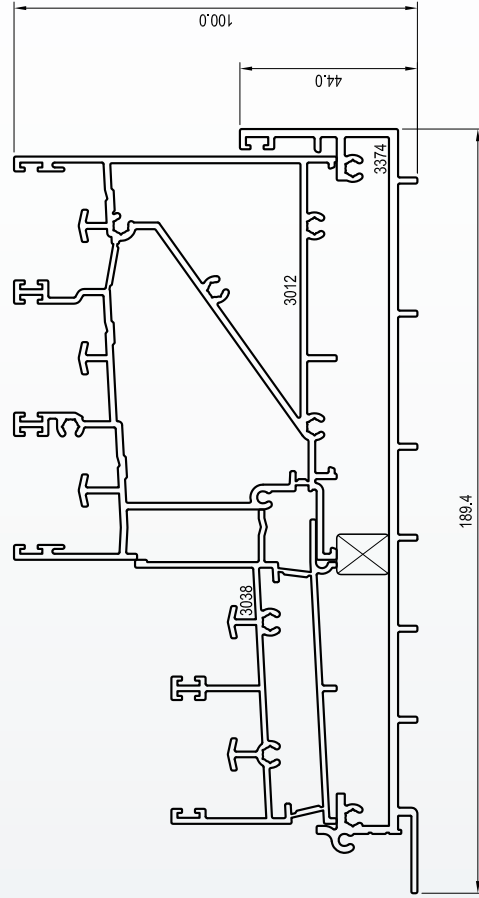

NOTE: REQUIRED PACKING TO BE SUPPLIED & FITTED BY BRADNAM'S OR LICENSEE.

3012 SILL 3 TRACK 600Pa & 3038 SILL PLANT-ON WITH 3335 & 3337 SUBSILLS

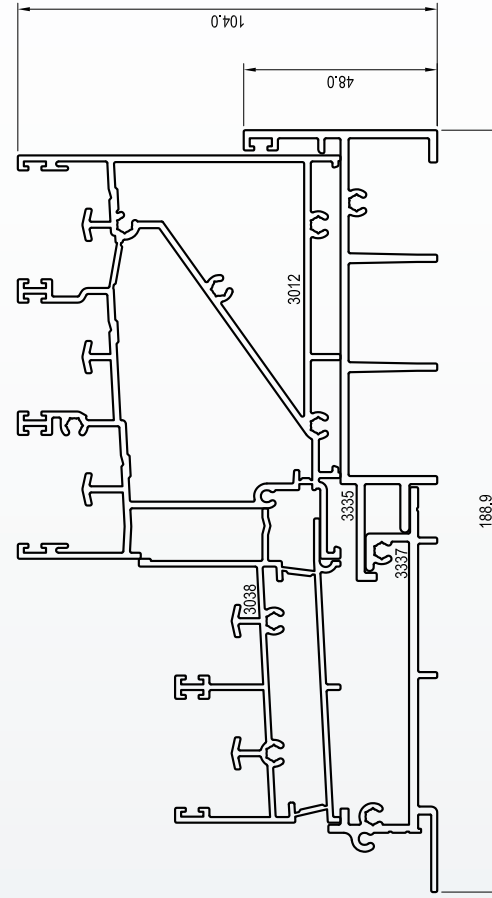



# SILL REBATES

Note: Diagrams are not to scale

## Signature Sliding Door 166

3033 SILL 5 TRACK

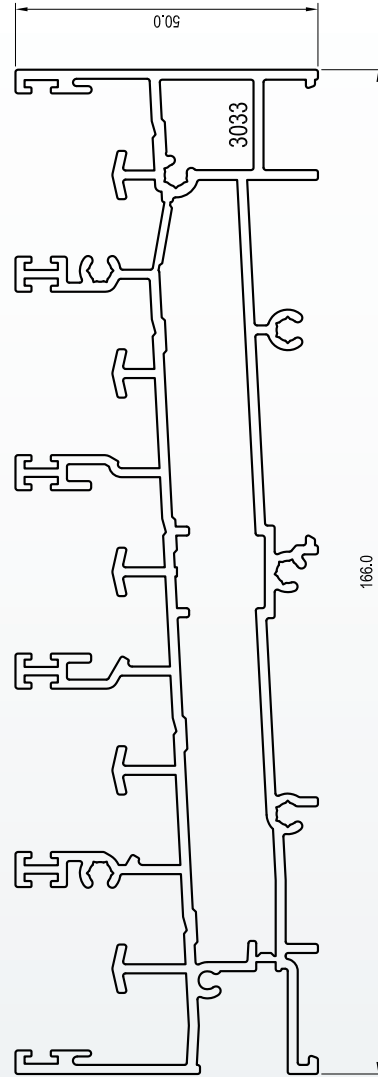

3435 SILL 166 LP 17

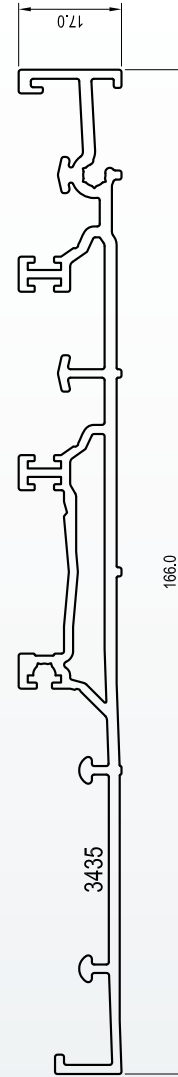

3431 SILL 166 LP 32

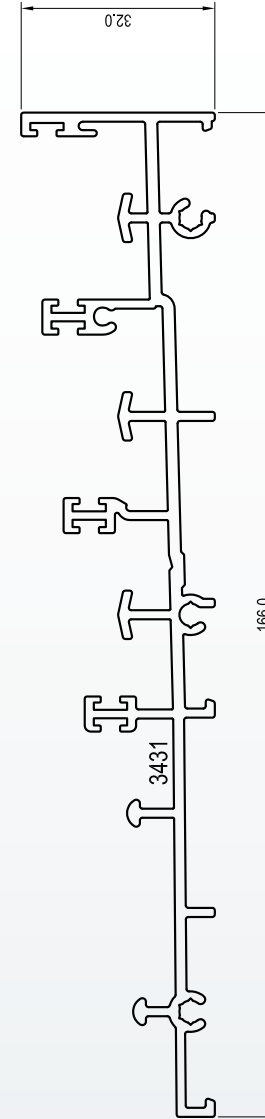

# SILL REBATES

Note: Diagrams are not to scale

## Signature Sliding Door 166

3033 SILL 5 TRACK WITH 3349 SUBSILL '15' 166

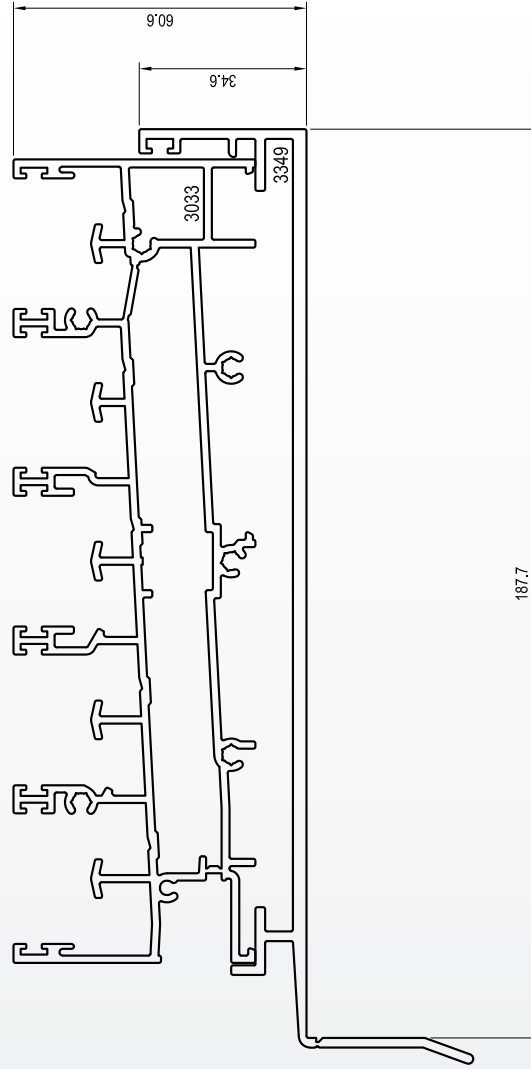

3033 SILL 5 TRACK WITH 3374 SUBSILL BAFFLED 166

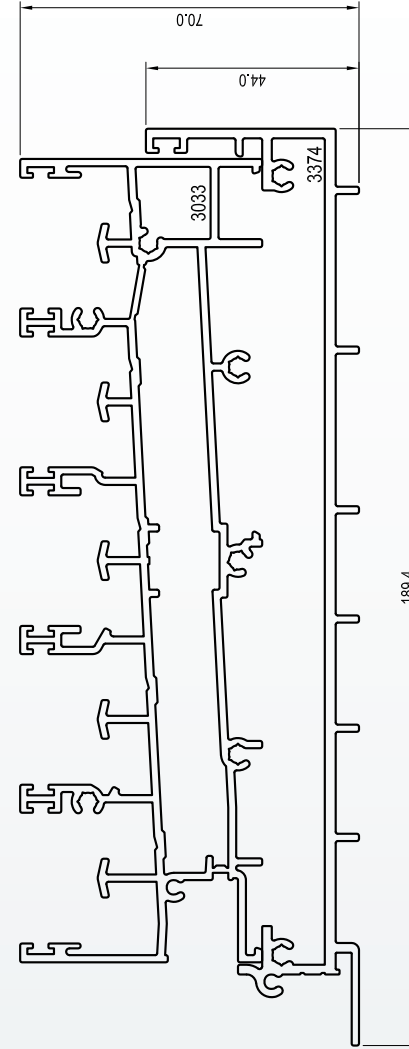

# SILL REBATES

Note: Diagrams are not to scale

## Signature Sliding Door 166

3431 SILL 166 LP 32 WITH 3349 SUBSILL '15' 166

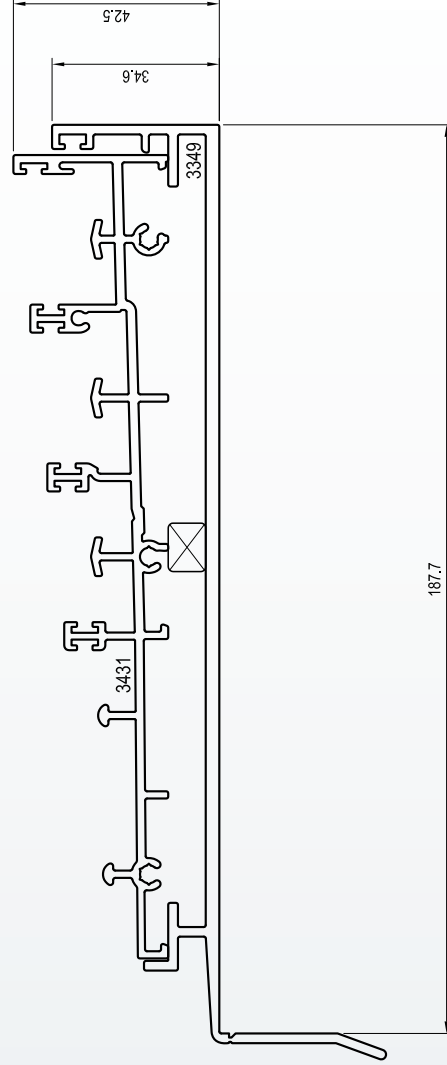

NOTE: REQUIRED PACKING TO BE SUPPLIED & FITTED BY BRADNAM'S OR LICENSEE.

3431 SILL 166 LP 32 WITH 3374 SUBSILL BAFFLED 166

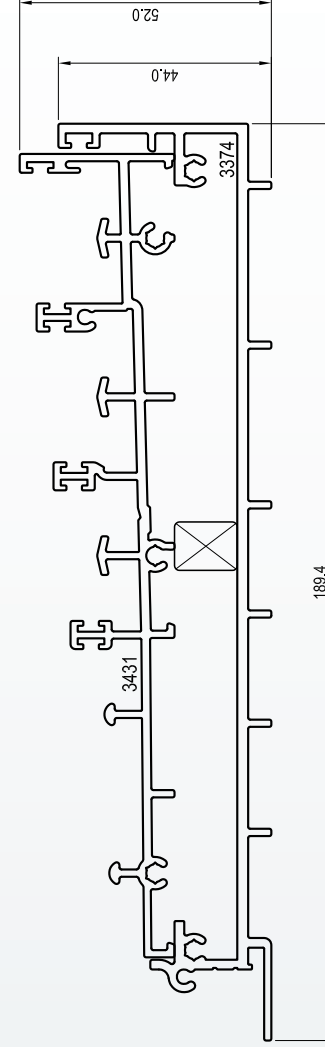

NOTE: REQUIRED PACKING TO BE SUPPLIED & FITTED BY BRADNAM'S OR LICENSEE.

# SILL REBATES

Note: Diagrams are not to scale

## Signature Sliding Door 166

3033 SILL 5 TRACK & 3038 SILL PLANT-ON

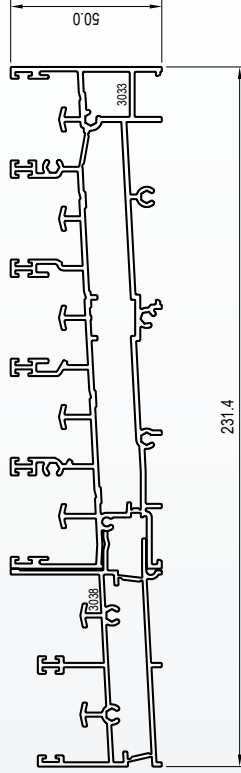

3033 SILL 5 TRACK & 3370 SILL 4 TRACK WITH 3372 ADAPTOR 4 TRACK

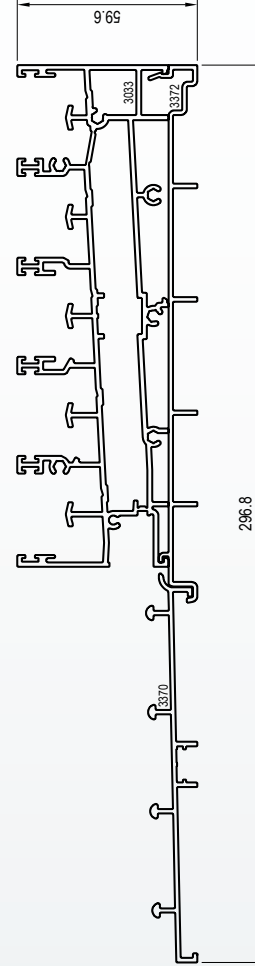

3033 SILL 5 TRACK & 3370 SILL 4 TRACK WITH 3374 SUBSILL BAFFLED 166

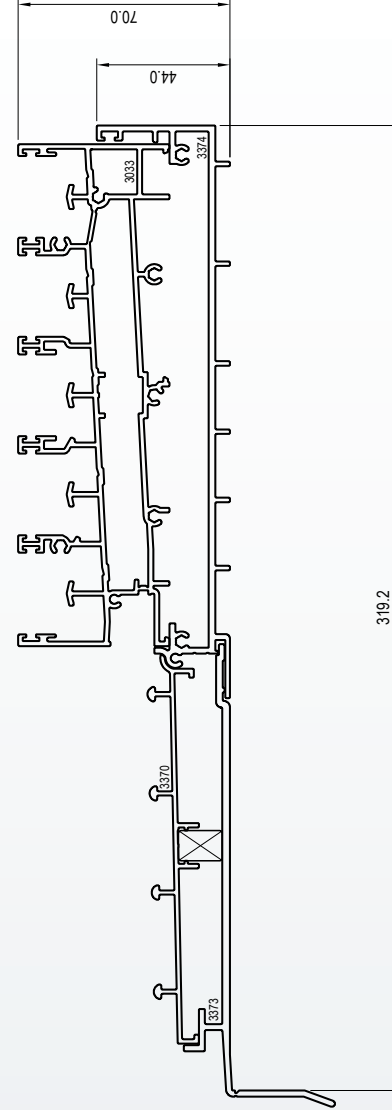

NOTE: REQUIRED PACKING TO BE SUPPLIED & FITTED BY BRADNAM'S OR LICENSEE.

# SILL REBATES

Note: Diagrams are not to scale

## Signature Sliding Door 100

3434 SILL 100 LP 17 WITH 3115 RAMP UPPER

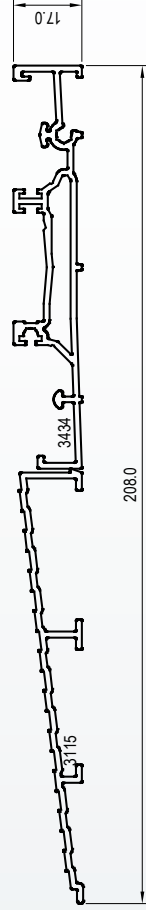

3430 SILL 100 LP 32 WITH 3115 RAMP UPPER

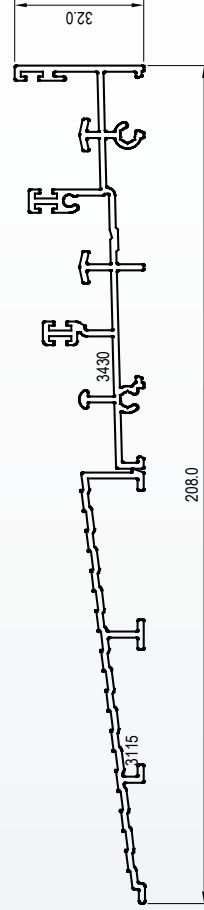

3430 SILL 100 LP 32 WITH 3115 RAMP UPPER & 3116 RAMP LOWER

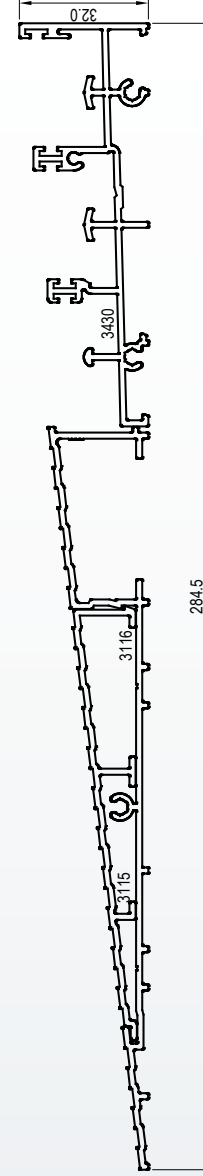

NOTE: REQUIRED PACKING TO BE SUPPLIED & FITTED BY BRADNAM'S OR LICENSEE.

# SILL REBATES

Note: Diagrams are not to scale

## Commercial Sliding Door 100

2552 SILL 2 TRACK STD

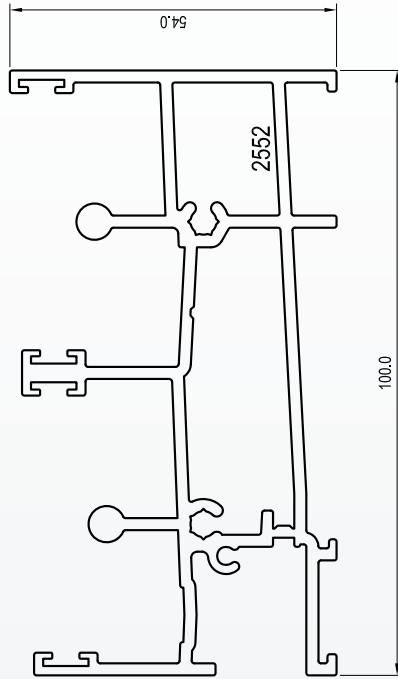

2552 SILL 2 TRACK STD WITH 3353 SUBSILL '15' 100

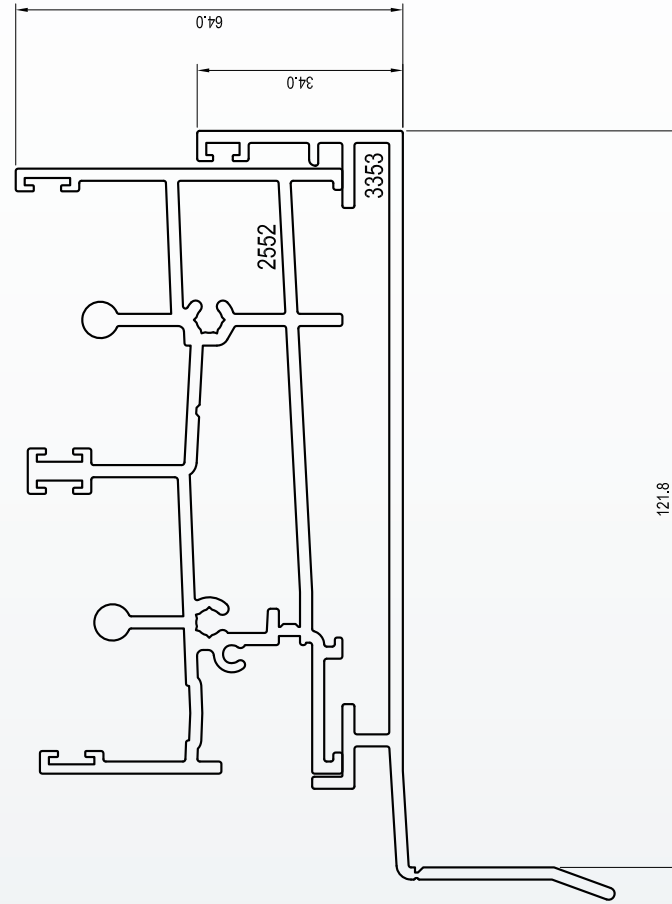

# SILL REBATES

Note: Diagrams are not to scale

## Commercial Sliding Door 100

2552 SILL 2 TRACK STD WITH 2876 SUBSILL '35' 100

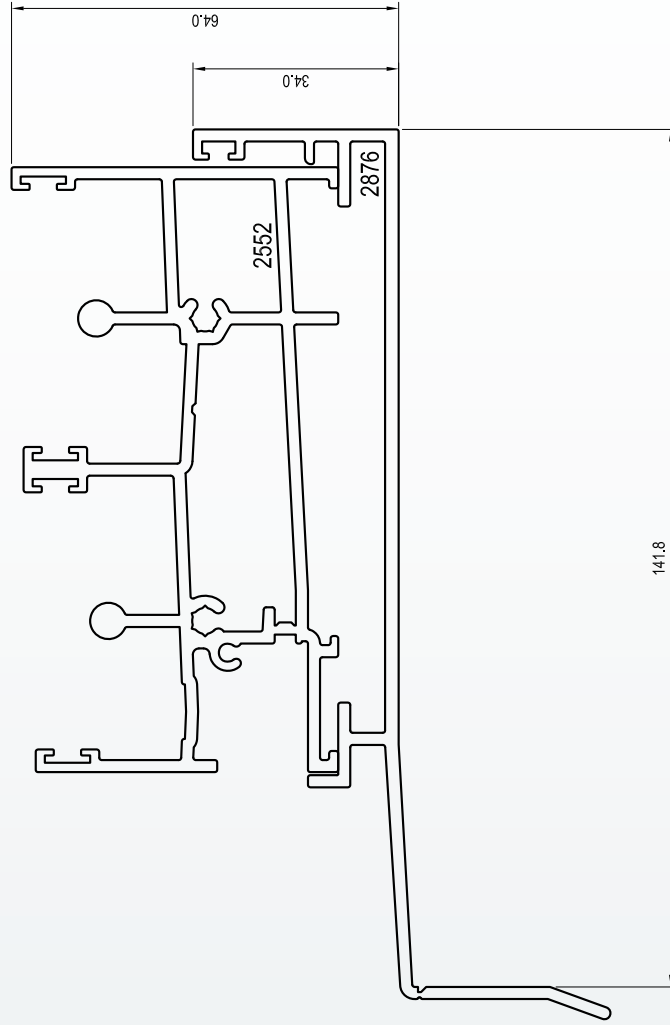

2552 SILL 2 TRACK STD WITH 3017 SUBSILL BAFFLED 100

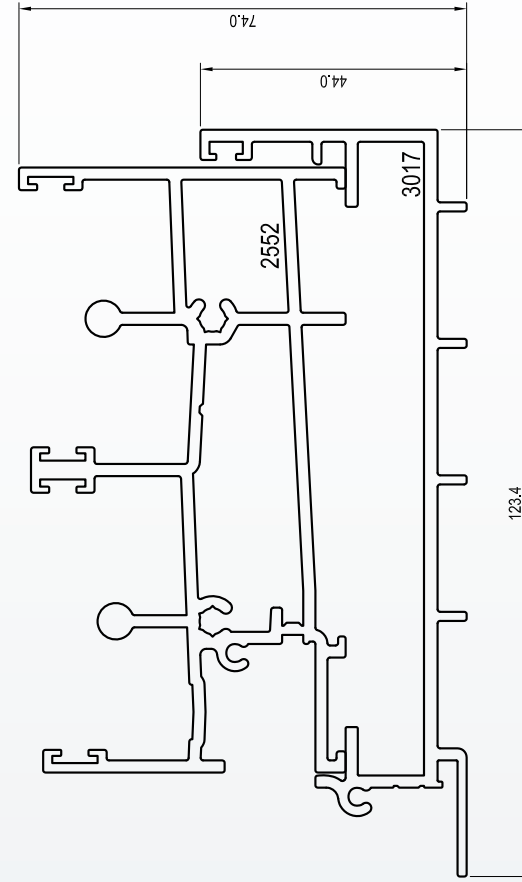

# SILL REBATES

Note: Diagrams are not to scale

## Commercial Sliding Door 100

2580 SILL 2 TRACK HP

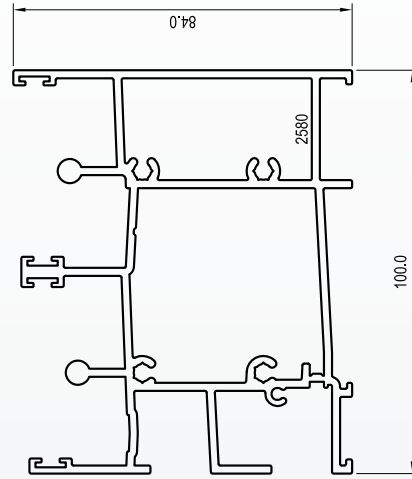

2580 SILL 2 TRACK HP WITH 3353 SUBSILL '15' 100

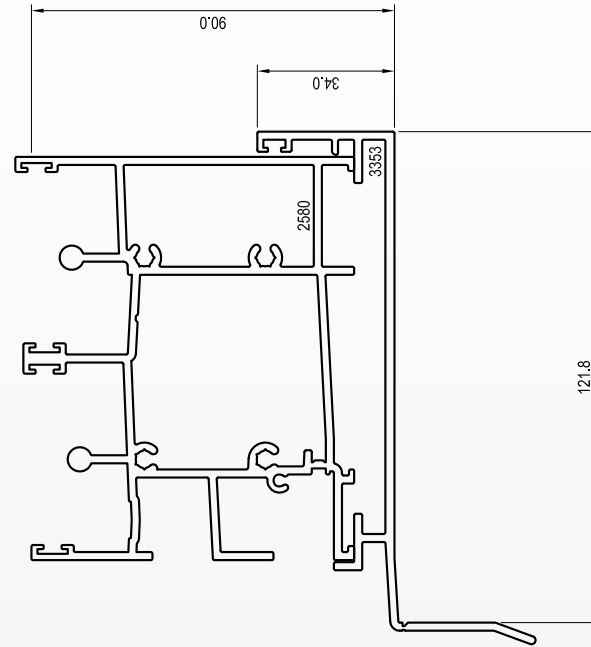



# SILL REBATES

Note: Diagrams are not to scale

## Commercial Sliding Door 100

2580 SILL 2 TRACK HP WITH 2876 SUBSILL '35' 100

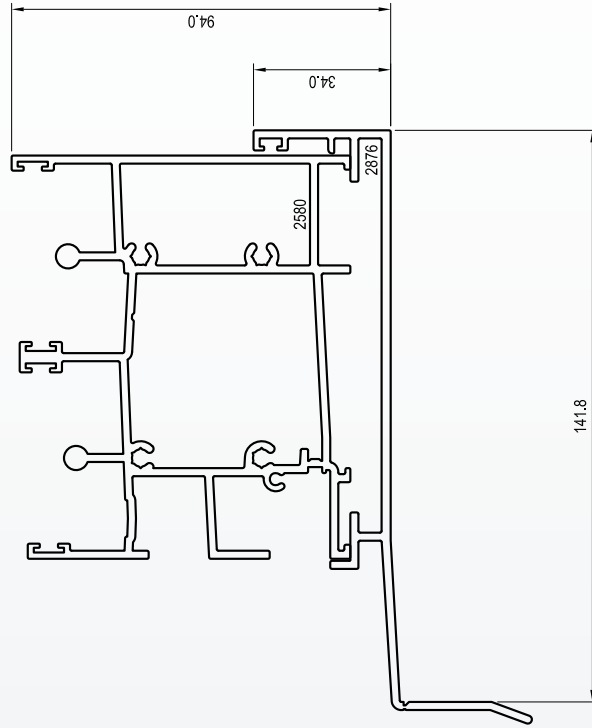

2580 SILL 2 TRACK HP WITH 3017 SUBSILL BAFFLED 100

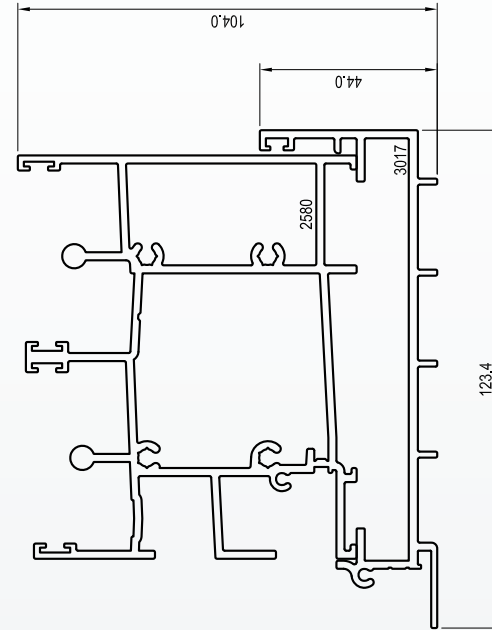

# SILL REBATES

Note: Diagrams are not to scale

## Commercial Sliding Door 100

2552 SILL 2 TRACK STD & 3038 SILL PLANT-ON

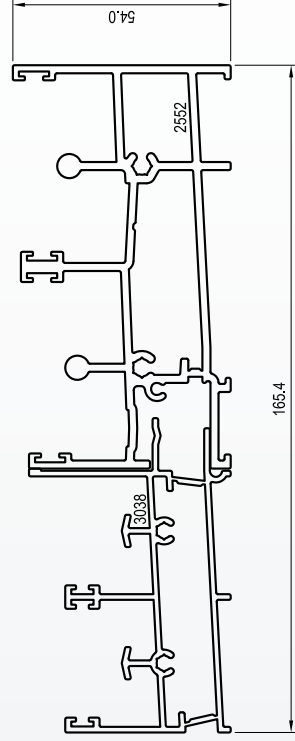

2552 SILL 2 TRACK STD & 3038 SILL PLANT-ON WITH 3349 SUBSILL '15' 166

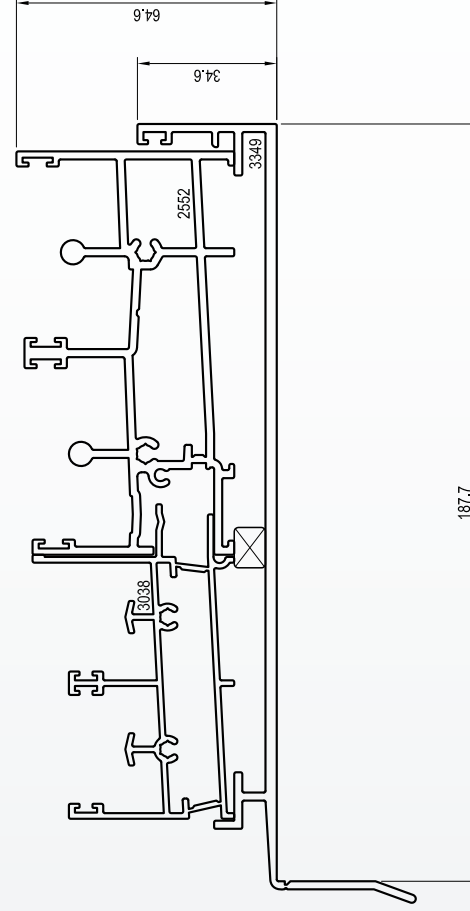

NOTE: REQUIRED PACKING TO BE SUPPLIED & FITTED BY BRADNAM'S OR LICENSEE.

# SILL REBATES

Note: Diagrams are not to scale

## Commercial Sliding Door 100

2552 SILL 2 TRACK STD & 3038 SILL PLANT-ON WITH 3374 SUBSILL BAFFLED 166

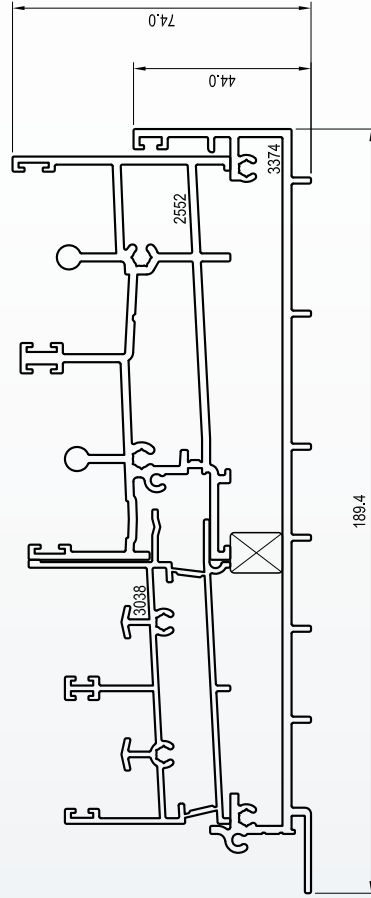

NOTE: REQUIRED PACKING TO BE SUPPLIED & FITTED BY BRADNAM'S OR LICENSEE.

2552 SILL 2 TRACK STD & 3038 SILL PLANT-ON WITH 3335 & 3337 SUBSILLS

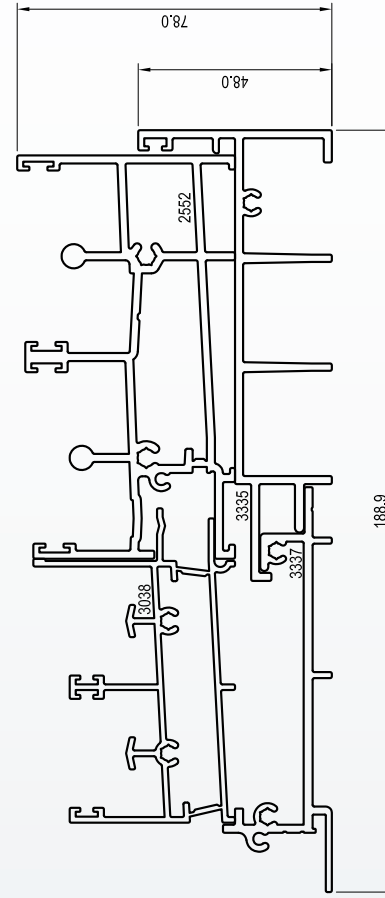

# SILL REBATES

Note: Diagrams are not to scale

## Commercial Sliding Door 100

2580 SILL 2 TRACK HP & 3038 SILL PLANT-ON

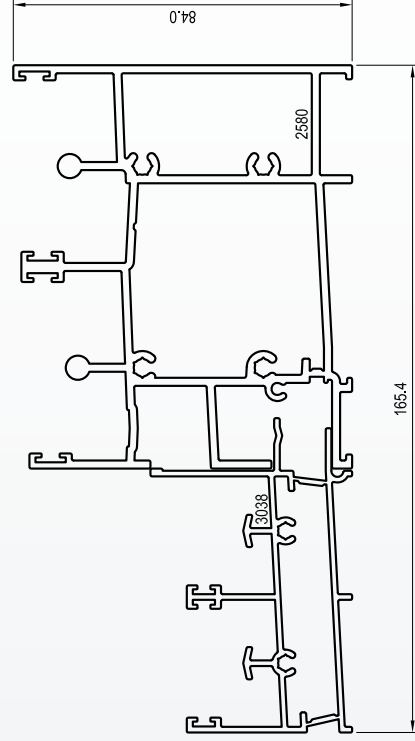

2580 SILL 2 TRACK HP & 3038 SILL PLANT-ON WITH 3349 SUBSILL '15' 166

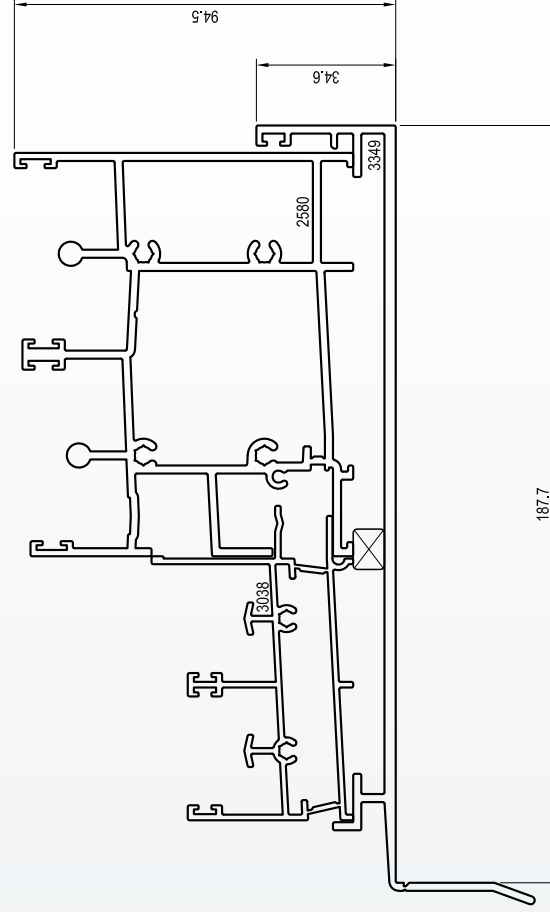

NOTE: REQUIRED PACKING TO BE SUPPLIED & FITTED BY BRADNAM'S OR LICENSEE.

# SILL REBATES

Note: Diagrams are not to scale

## Commercial Sliding Door 100

2580 SILL 2 TRACK HP & 3038 SILL PLANT-ON WITH 3374 SUBSILL BAFFLED 166

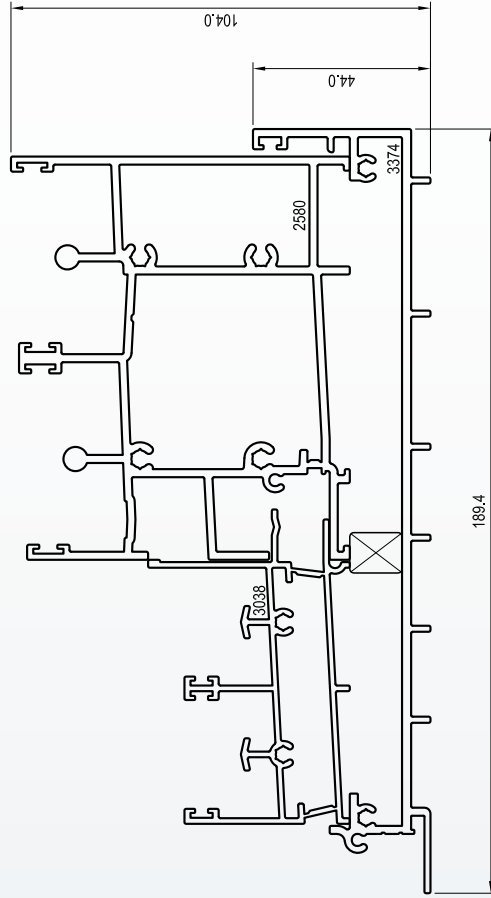

NOTE: REQUIRED PACKING TO BE SUPPLIED & FITTED BY BRADNAM'S OR LICENSEE.

2580 SILL 2 TRACK HP & 3038 SILL PLANT-ON WITH 3335 & 3337 SUBSILLS

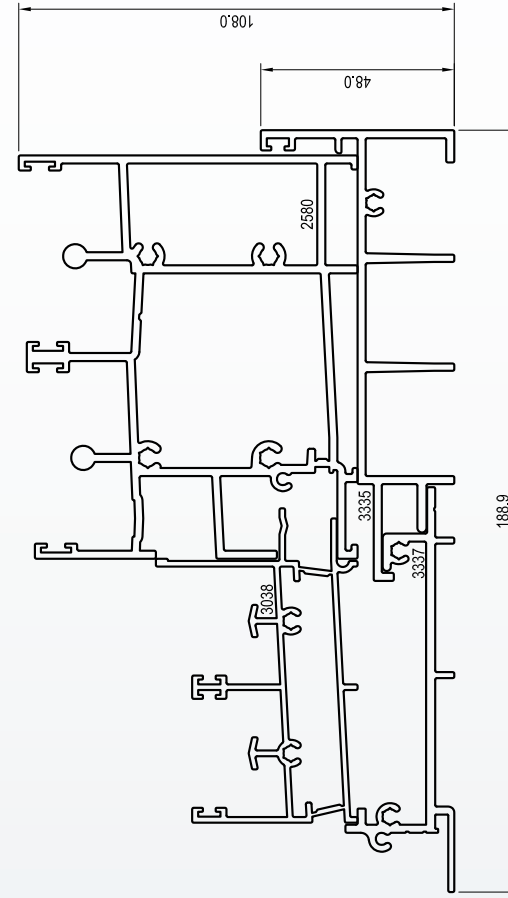

# SILL REBATES

Note: Diagrams are not to scale

## Commercial Sliding Door 150

2572 SILL 3 TRACK STD

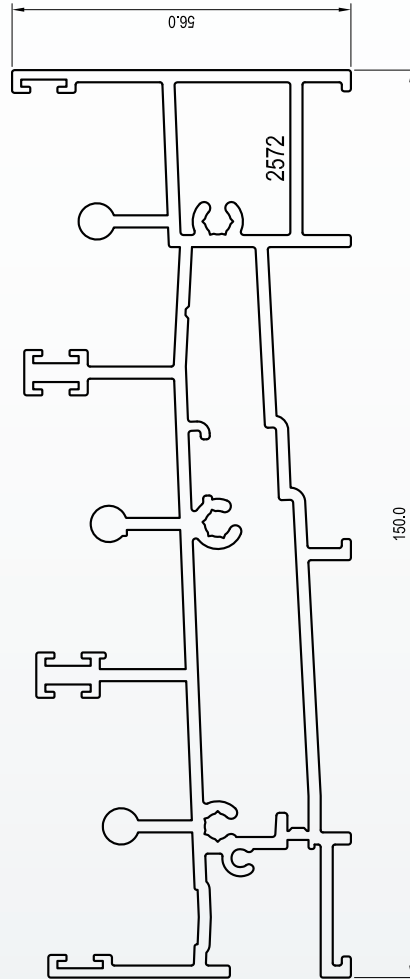

2572 SILL 3 TRACK STD WITH 2879 SUBSILL '1' 150

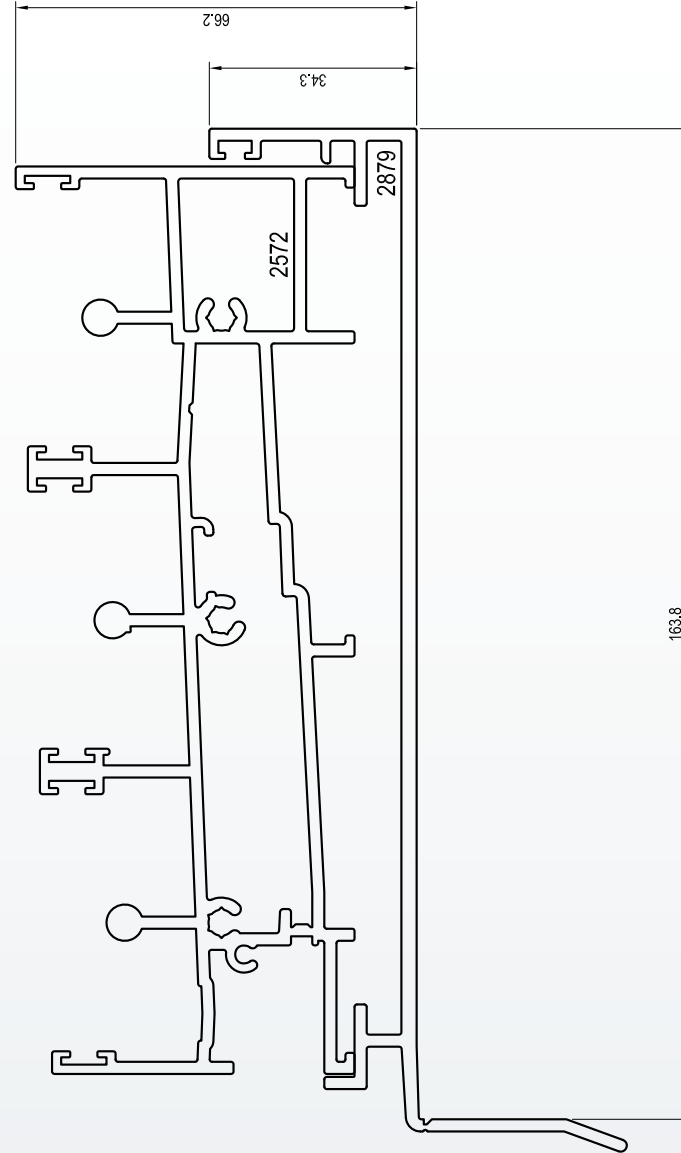

# SILL REBATES

Note: Diagrams are not to scale

## Commercial Sliding Door 150

2581 SILL 3 TRACK HP

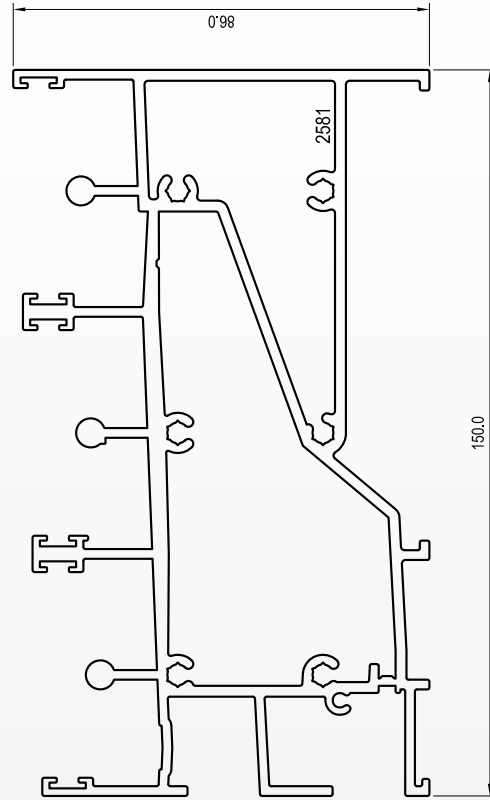

2581 SILL 3 TRACK HP WITH 2879 SUBSILL '7' 150

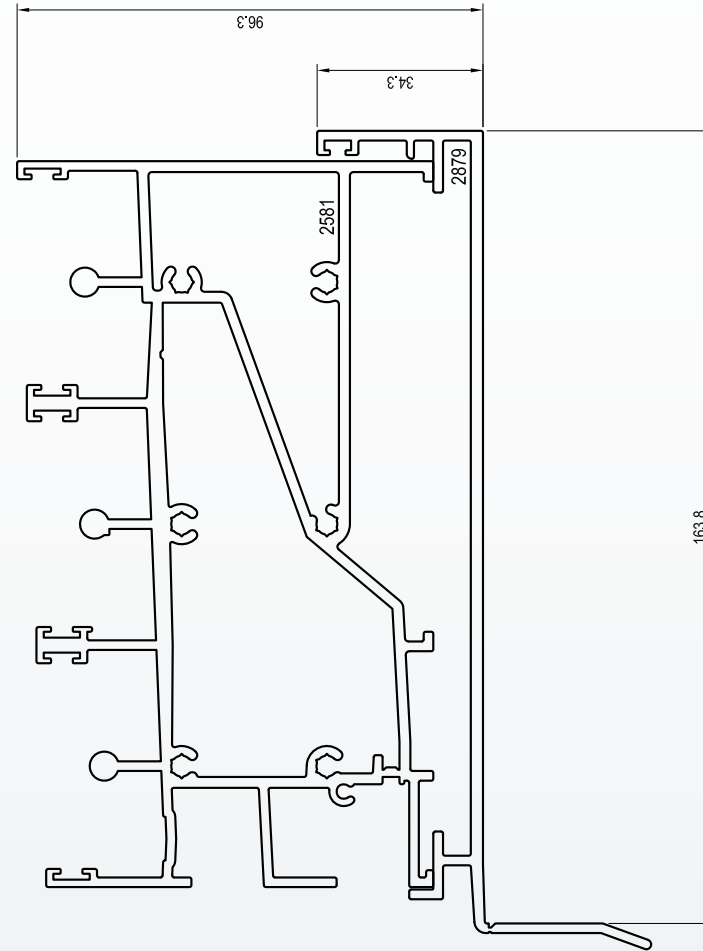

# SILL REBATES

Note: Diagrams are not to scale

## Commercial Sliding Door 150

2572 SILL 3 TRACK STD & 3038 SILL PLANT-ON

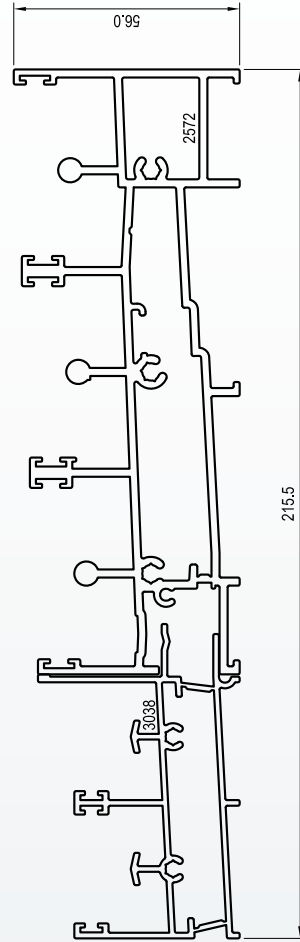

2572 SILL 3 TRACK STD & 3038 SILL PLANT-ON WITH 3336 & 3337 SUBSILLS

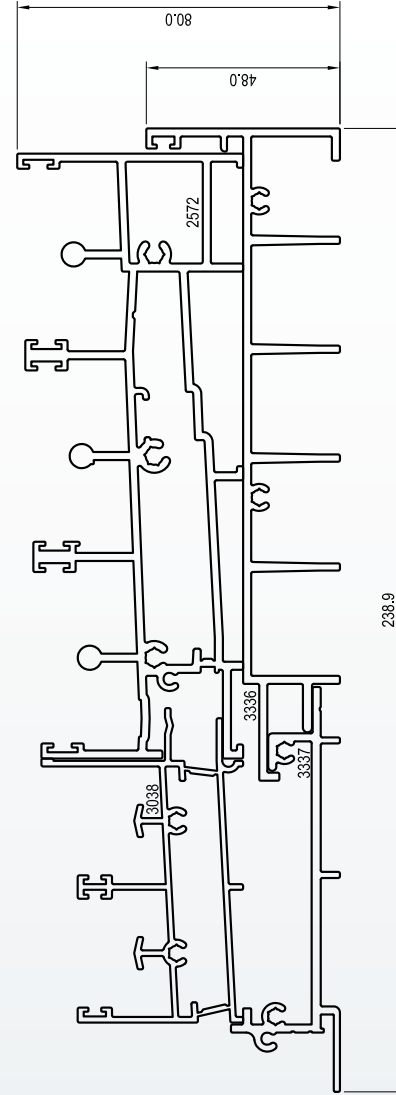



# SILL REBATES

Note: Diagrams are not to scale

## Commercial Sliding Door 150

2581 SILL 3 TRACK HP & 3038 SILL PLANT-ON

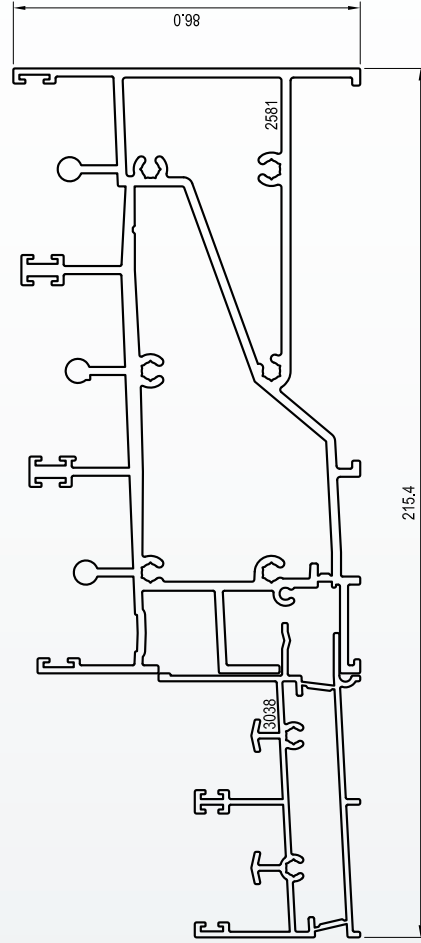

2581 SILL 3 TRACK HP & 3038 SILL PLANT-ON WITH 3336 & 3337 SUBSILLS

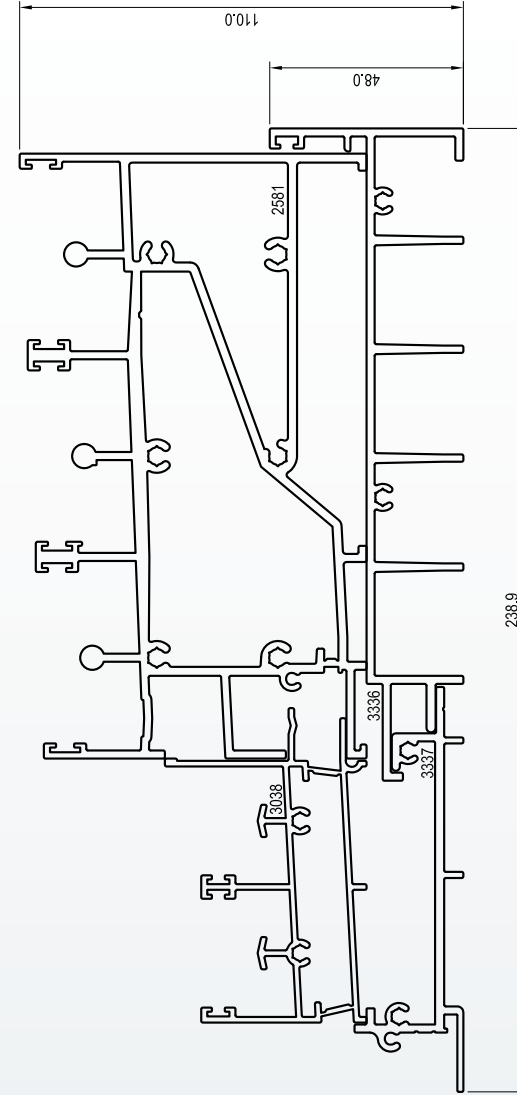

# SILL REBATES

Note: Diagrams are not to scale

## Commercial Sliding Door 100 & 150

3439 SILL 2 TRACK LP

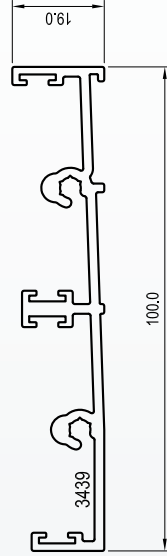

3439 SILL 2 TRACK LP WITH 3438 SILL PLANT-ON LP

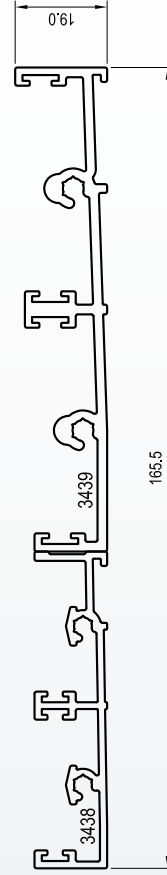

3440 SILL 3 TRACK LP

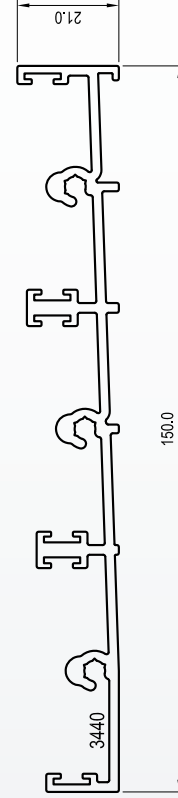

3440 SILL 3 TRACK LP WITH 3438 SILL PLANT-ON LP

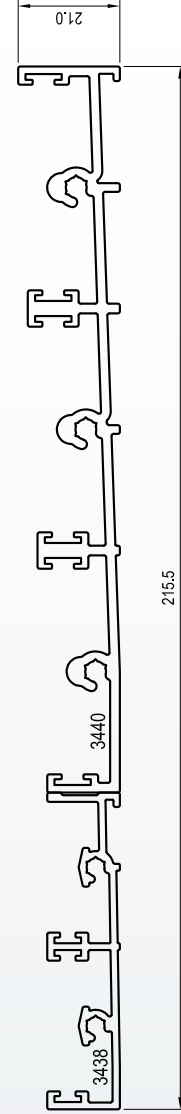

# SILL REBATES

Note: Diagrams are not to scale

## Commercial Sliding Door 200

SILL 4 TRACK STD ASSEMBLY

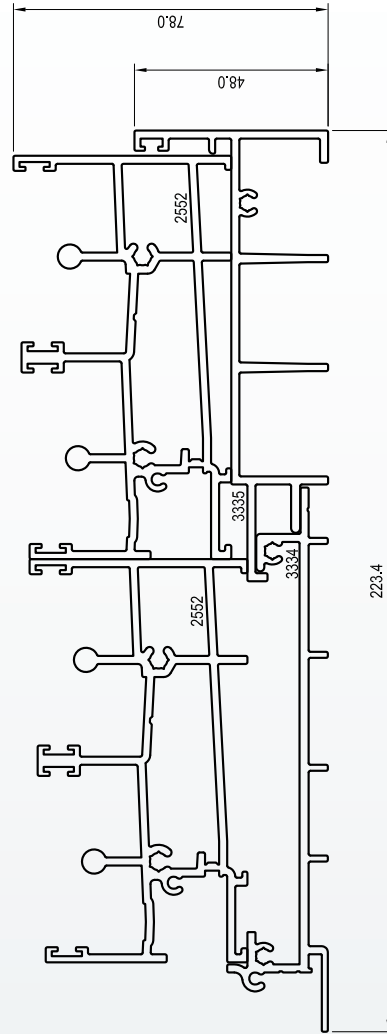

SILL 4 TRACK HP ASSEMBLY

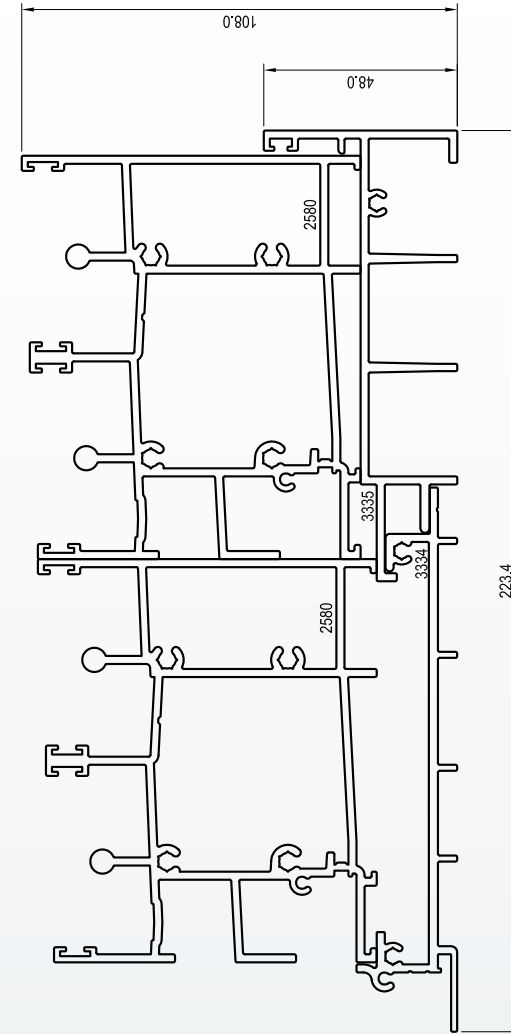

# SILL REBATES

Note: Diagrams are not to scale

## Commercial Sliding Door 250

SILL 5 TRACK STD ASSEMBLY

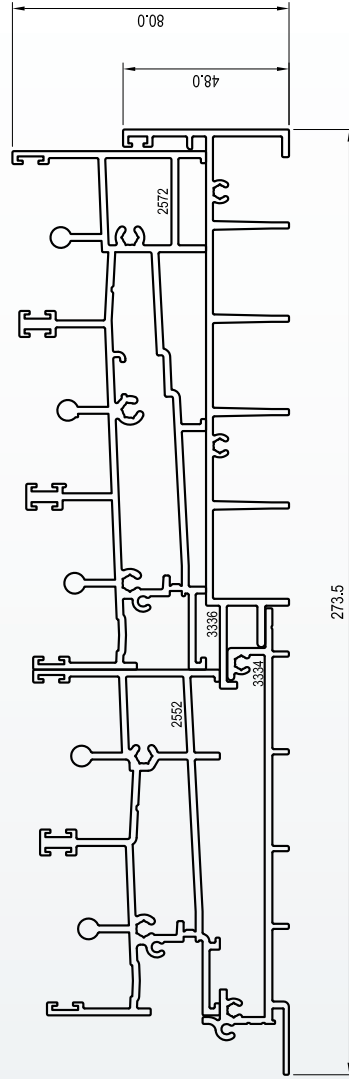

SILL 5 TRACK HP ASSEMBLY

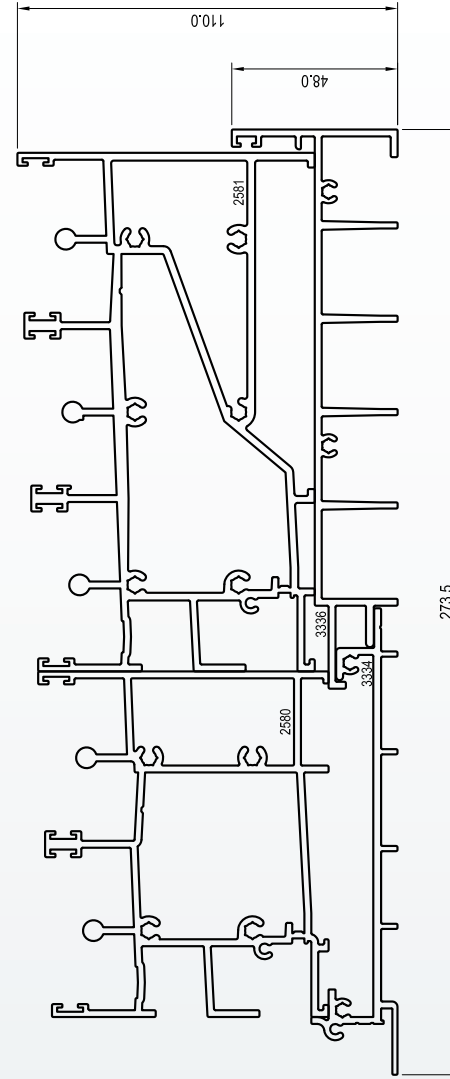

# SILL REBATES

Note: Diagrams are not to scale

## Commercial Sliding Door 200

SILL 4 TRACK STD ASSEMBLY WITH 3370 SILL SCREEN & 3373 SUBSILL

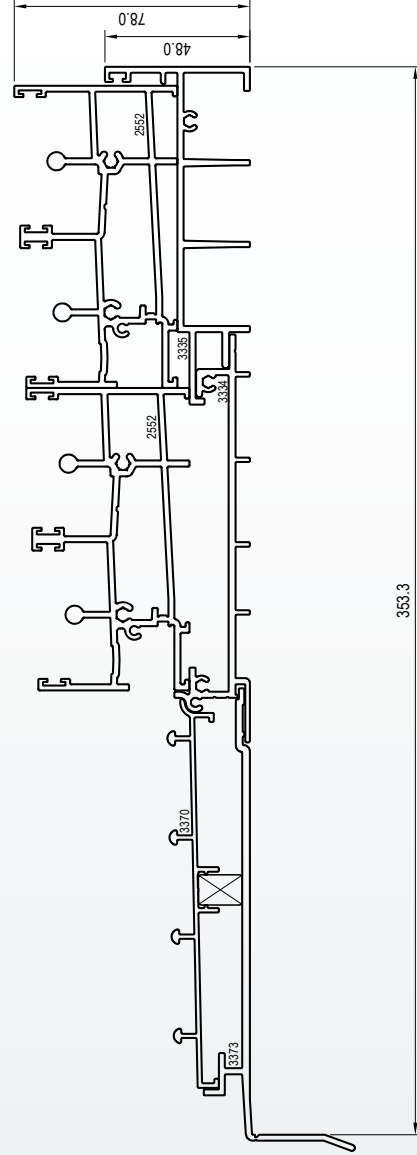

NOTE: REQUIRED PACKING TO BE SUPPLIED & FITTED BY BRADNAM'S OR LICENSEE.

SILL 4 TRACK HP ASSEMBLY WITH 3370 SILL SCREEN & 3373 SUBSILL

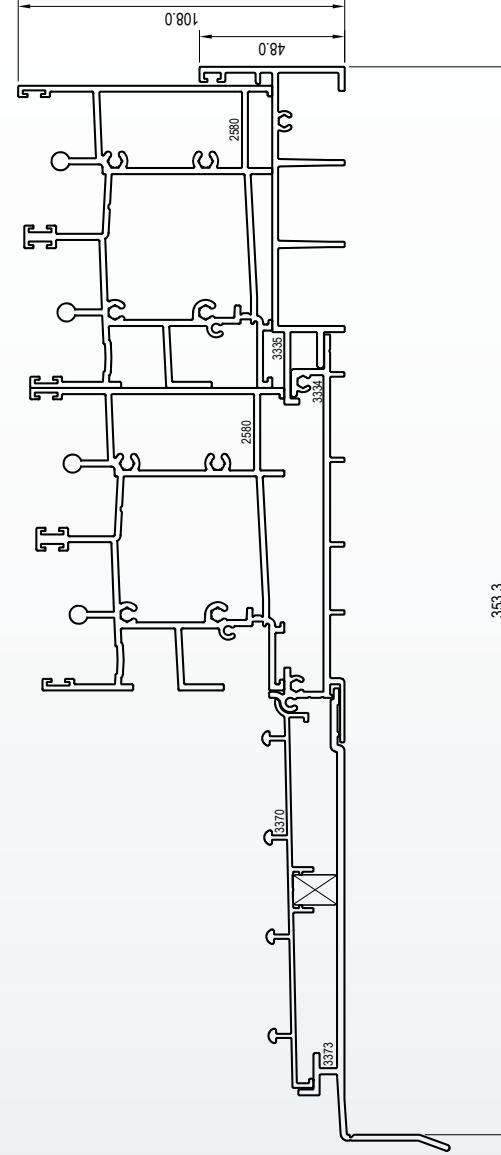

NOTE: REQUIRED PACKING TO BE SUPPLIED & FITTED BY BRADNAM'S OR LICENSEE.

# SILL REBATES

Note: Diagrams are not to scale

## Commercial Sliding Door 250

### SILL 5 TRACK STD ASSEMBLY WITH 3370 SILL SCREEN & 3373 SUBSILL

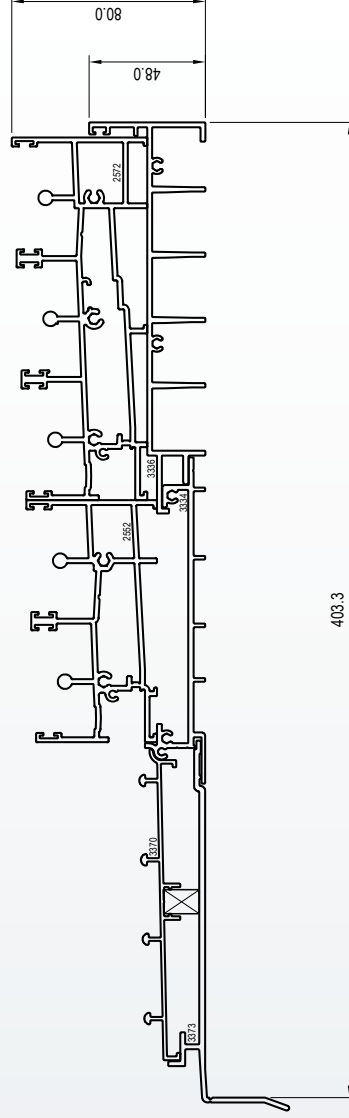

NOTE: REQUIRED PACKING TO BE SUPPLIED & FITTED BY BRADNAM'S OR LICENSEE.

### SILL 5 TRACK HP ASSEMBLY WITH 3370 SILL SCREEN & 3373 SUBSILL

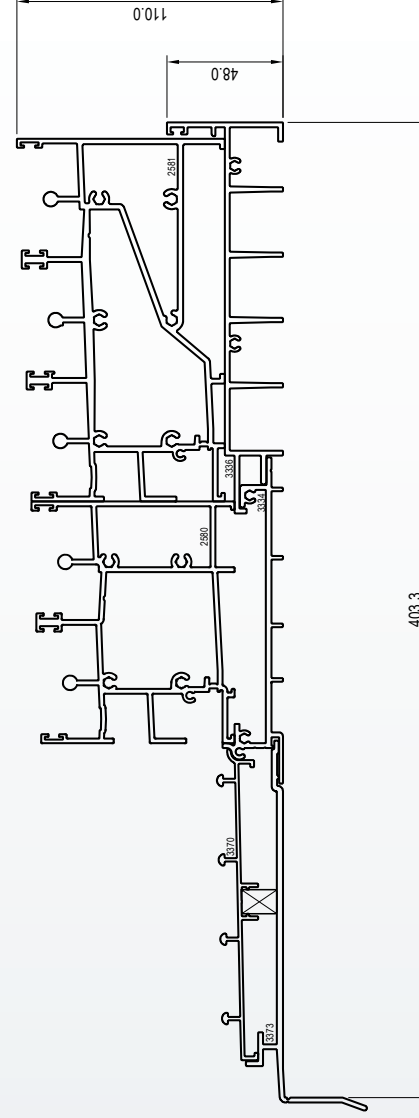

NOTE: REQUIRED PACKING TO BE SUPPLIED & FITTED BY BRADNAM'S OR LICENSEE.