



BRADNAM'S

# SLIDING WINDOWS

## PRODUCT INFORMATION

Product performance is subject to regional variations, design requirements and building codes. Performance parameters are independent of each other.

Images are for illustration purposes only and may not accurately represent the product. Bradnam's Windows & Doors reserves the right to change, alter or delete any aspect of this product without notice.



PERFORMANCE PARAMETERS

CONFIGURATIONS

STANDARD SIZES

COLONIAL BAR OPTIONS

PROFILE DIMENSIONS

REVEAL SETBACKS

SILL REBATES

## PERFORMANCE PARAMETERS

	Essential	Signature
Frame size	52mm	67mm / 100mm
Maximum window height (with transoms)	2400mm	2700mm
Maximum window height (without transoms)	1600mm	2000mm
Maximum window width	3010mm	5400mm
Maximum panel width	1500mm	1350mm
Maximum panel weight	24kg	100kg
Maximum water rating	600Pa	600Pa
Maximum wind rating	4500Pa ULS	6000Pa ULS
Maximum glass thickness (single glazed)	6.76mm	12.76mm
Maximum glass thickness (double glazed)	N/A	20mm
Maximum acoustic rating	Rw30	Rw35
Maximum bushfire rating	BAL 40	BAL 40
Lowest U-value (single glazed)	4.4	4.0
Lowest U-value (double glazed)	N/A	3.0

**Note:** Performance figures are independent of each other and subject to conditions. Contact a Bradnam's Windows & Doors representative to discuss your specific project requirements.

# CONFIGURATIONS

## Standard



SF

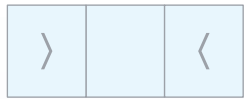

SFS



FSSF



SF/F

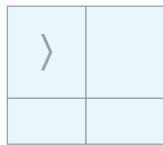

SF/FF

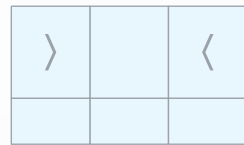

SFS/FFF

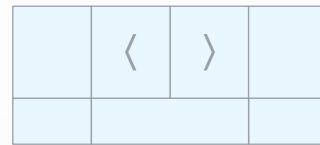

FSSF/FFF

## Designer



SSF



FSSSSF



















SSF/FFF

Other Designer configurations available

# STANDARD SIZES – QUEENSLAND

The availability of certain sizes and configurations is dependent on the design wind load requirement as per AS2047-2014. Check with your Bradnam's representative to confirm availability. Sliding Windows may be subject to local variation or regulatory requirements.

+ Available Single or Double Glazed (Signature version only)

STUD OPENING mm		660	960	1260	1560	1860	2160	2460	2760	3060
FRAME SIZE mm		610	910	1210	1510	1810	2110	2410	2710	3010
650	600	 SF0606	 SF0609	 SF0612	 SF0615	 SF0618	 SF0621	 SFS0624	 SFS0627	 SFS0630
	950	 SF0906	 SF0909	 SF0912	 SF0915	 SF0918	 SF0921	 SFS0924	 SFS0927	 SFS0930
1050	1000	 SF1006	 SF1009	 SF1012	 SF1015	 SF1018	 SF1021	 SFS1024	 SFS1027	 SFS1030
	1250		 SF1209	 SF1212	 SF1215	 SF1218	 SF1221	 SFS1224	 SFS1227	 SFS1230
1550	1500			 SF1512	 SF1515	 SF1518	 SF1521	 SFS1524	 SFS1527	 SFS1530
	1850		 SF/F1809	 SF/F1812	 SF/FF1815	 SF/FF1818	 SF/FF1821	 SFS/FFF1824	 SFS/FFF1827	 SFS/FFF1830
2150	2100		 SF/F2112	 SF/FF2115	 SF/FF2118	 SF/FF2121	 SFS/FFF2124	 SFS/FFF2127	 SFS/FFF2130	

Viewed from exterior: S = Sliding Panel, F = Fixed Panel

Sliding Windows are also available in FS or FSSF configurations (minimum of 1810mm in width required)



# STANDARD SIZES – NEW SOUTH WALES

The availability of certain sizes and configurations is dependent on the design wind load requirement as per AS2047-2014. Check with your Bradnam’s representative to confirm availability. Sliding Windows may be subject to local variation or regulatory requirements.

 Available Single or Double Glazed (Signature version only)

STUD OPENING mm		670	910	1270	1630	1870	2230	2230	2470	2710	3070
FRAME SIZE mm		610	850	1210	1570	1810	2170	2170	2410	2650	3010
660	600	 XO0606	 XO0609	 XO0612	 XO0616	 XO0618	 XO0622	 XOX0622	 XOX0624	 XOX0627	 XOX0630
920	860	 XO0906	 XO0909	 XO0912	 XO0916	 XO0918	 XO0922	 XOX0922	 XOX0924	 XOX0927	 XOX0930
1090	1030	 XO1006	 XO1009	 XO1012	 XO1016	 XO1018	 XO1022	 XOX1022	 XOX1024	 XOX1027	 XOX1030
1260	1200	 XO1209	 XO1212	 XO1216	 XO1218	 XO1222	 XOX1222	 XOX1224	 XOX1227	 XOX1230	
1430	1370	 XO1412	 XO1416	 XO1418	 XO1422	 XOX1422	 XOX1424	 XOX1427	 XOX1430		
1520	1460	 XO1512	 XO1516	 XO1518	 XO1522	 XOX1522	 XOX1524	 XOX1527	 XOX1530		
1860	1800	 XO/O1809	 XO/O1812	 XO/OO1816	 XO/OO1818	 XO/OO1822	 XOX/OO1822	 XOX/OO1824	 XOX/OO1827	 XOX/OO1830	
2120	2060	 XO/O2112	 XO/OO2116	 XO/OO2118	 XO/OO2122	 XOX/OO2122	 XOX/OO2124	 XOX/OO2127	 XOX/OO2130		

Viewed from exterior: X = Sliding Panel, O = Fixed Panel

Sliding Windows are also available in OX or OXXO configurations (minimum of 1810mm in width required)



# STANDARD SIZES – VICTORIA

The availability of certain sizes and configurations is dependent on the design wind load requirement as per AS2047-2014. Check with your Bradnam’s representative to confirm availability. Sliding Windows may be subject to local variation or regulatory requirements.

STUD OPENING mm		670	910	1270	1510	1870	2230	2230	2470	2710	3070
FRAME SIZE mm		610	850	1210	1450	1810	2170	2170	2410	2650	3010
660	600	SF0606	SF0609	SF0612	SF0615	SF0618	SF0621	SFS0621	SFS0624	SFS0627	SFS0630
920	860	SF0906	SF0909	SF0912	SF0915	SF0918	SF0921	SFS0921	SFS0924	SFS0927	SFS0930
1090	1030	SF1006	SF1009	SF1012	SF1015	SF1018	SF1021	SFS1021	SFS1024	SFS1027	SFS1030
1260	1200	SF1209	SF1212	SF1215	SF1218	SF1221	SFS1221	SFS1224	SFS1227	SFS1230	
1520	1460	SF1409	SF1412	SF1415	SF1418	SF1421	SFS1421	SFS1424	SFS1427	SFS1430	
1860	1800	SF1809T	SF1812T	SF1815T	SF1818T	SF1821T	SFS1821T	SFS1824T	SFS1827T	SFS1830T	
2120	2060		SF2012T	SF2015T	SF2018T	SF2021T	SFS2021T	SFS2024T	SFS2027T	SFS2030T	

Viewed from exterior: **S** = Sliding Panel, **F** = Fixed Panel

Sliding Windows are also available in FS or FSSF configurations (minimum of 1810mm in width required)



# COLONIAL BAR OPTIONS

## Design Options

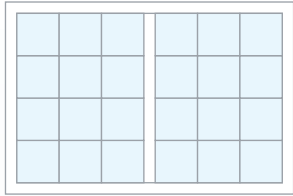

SF1218  
Traditional Colonial

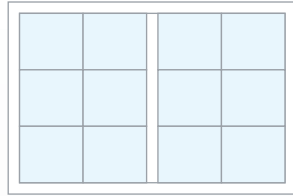

SF1218  
Australian Colonial

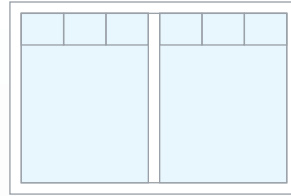

SF1218  
Highlander

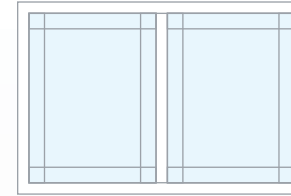

SF1218  
Traditional Federation

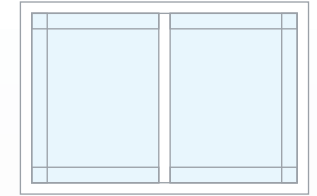

SF1218  
Australian Federation

## Types of Colonial Bar

Scale 5:1

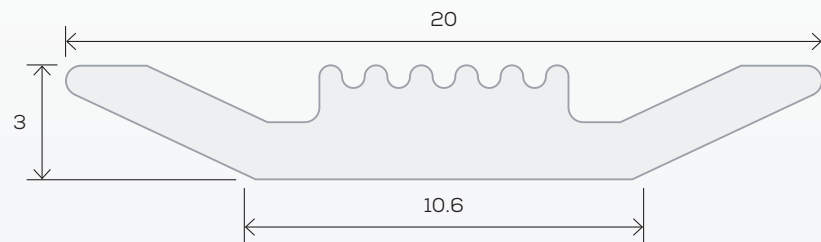

Raised



Flat

# PROFILE DIMENSIONS

Note: Diagrams are not to scale. They are illustrations only, and may not accurately represent the product. Their purpose is to show the profile dimensions.

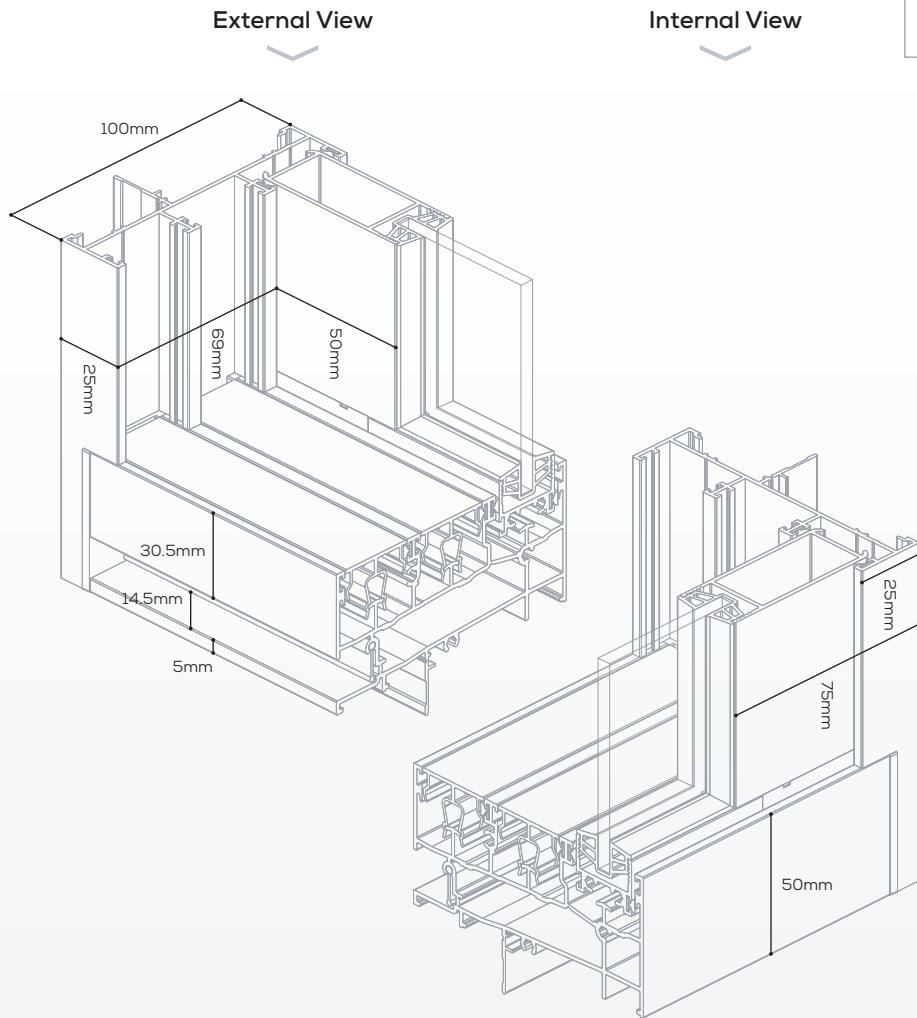

Signature Sliding Window 100

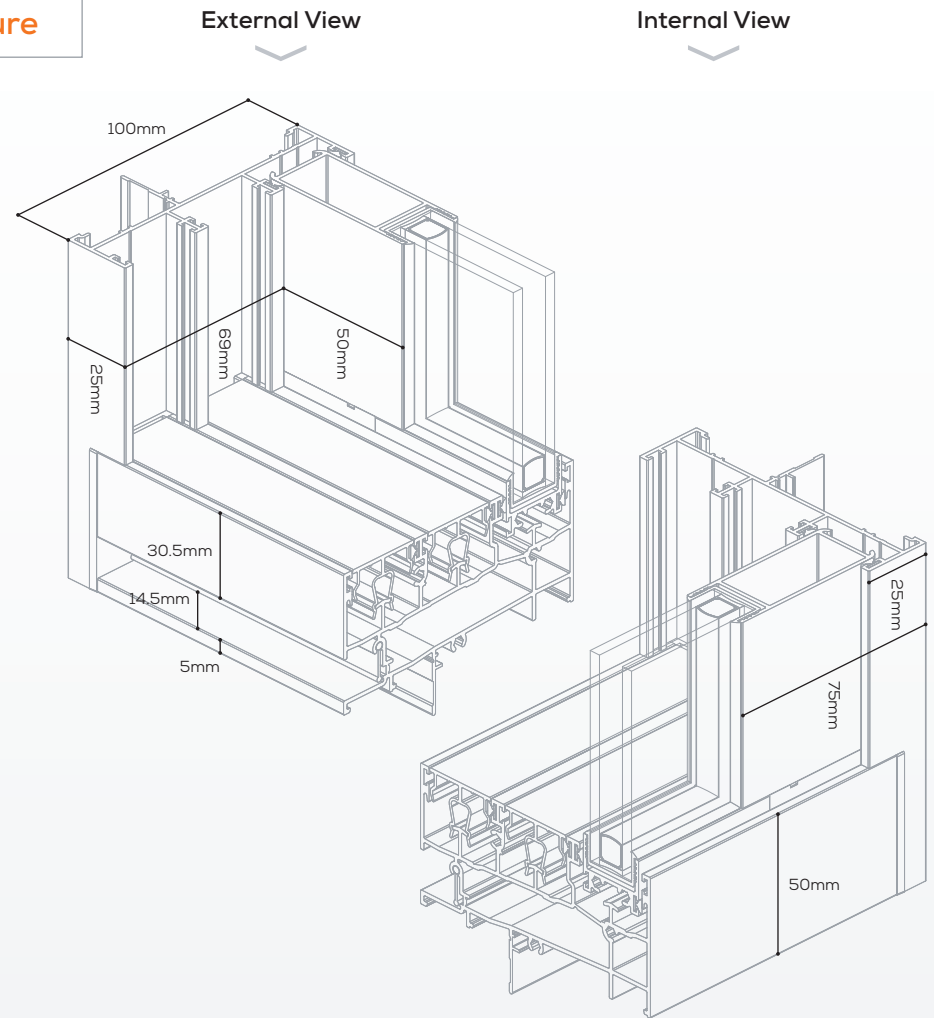

Signature Sliding Window 100 IGU



# PROFILE DIMENSIONS

Note: Diagrams are not to scale. They are illustrations only, and may not accurately represent the product. Their purpose is to show the profile dimensions.

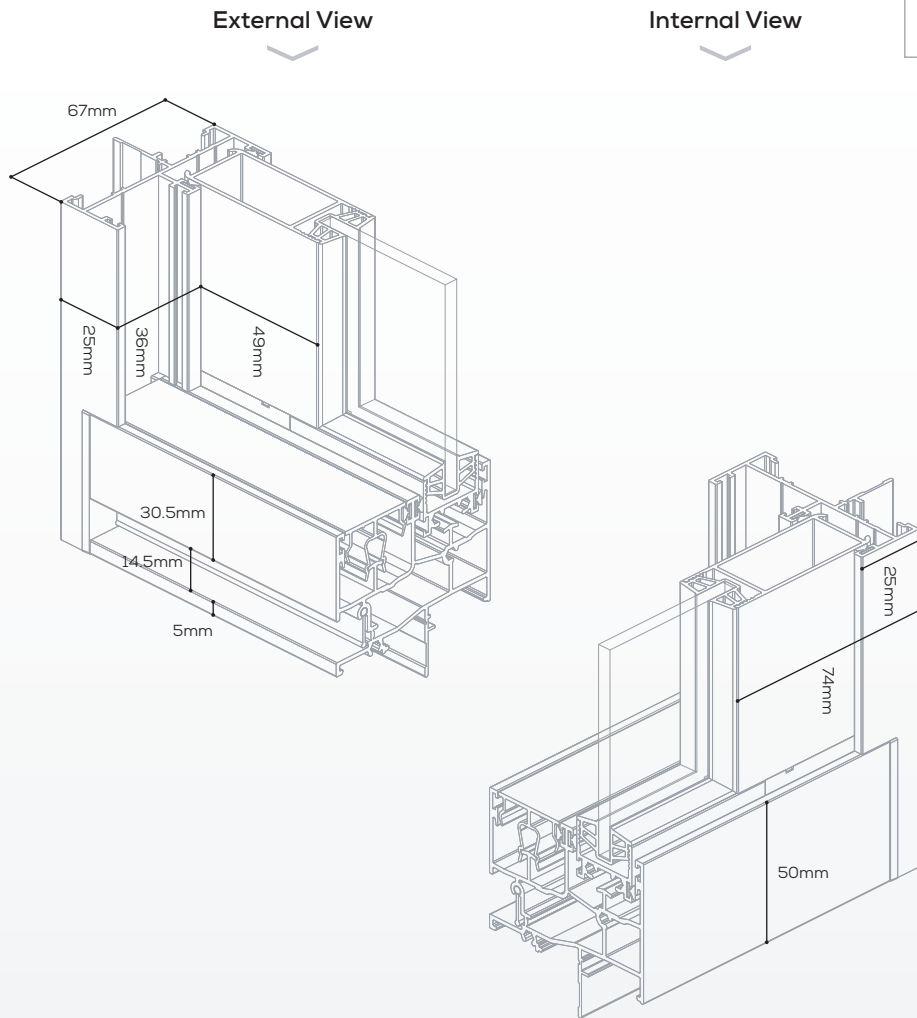

Signature Sliding Window 67

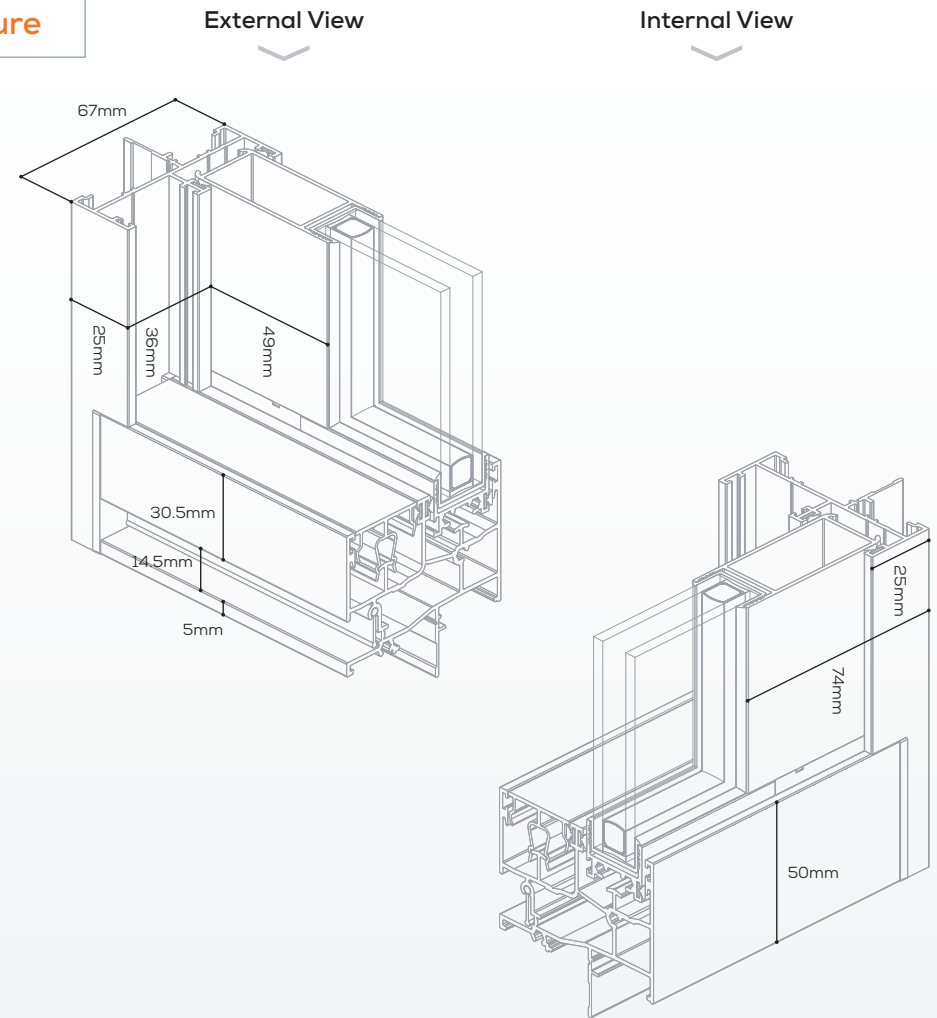

Signature Sliding Window 67 IGU

# REVEAL SETBACKS

Note: Diagrams are not to scale

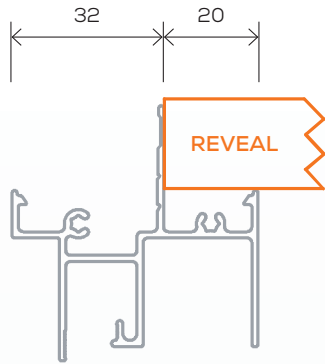

Essential Sliding Window (52mm)

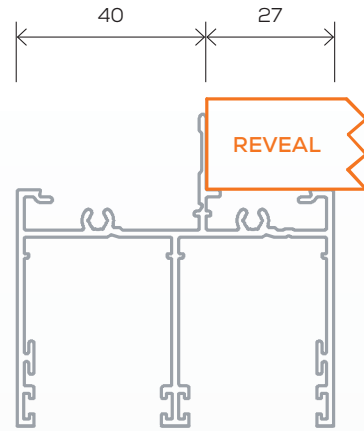

Signature Sliding Window (67mm)

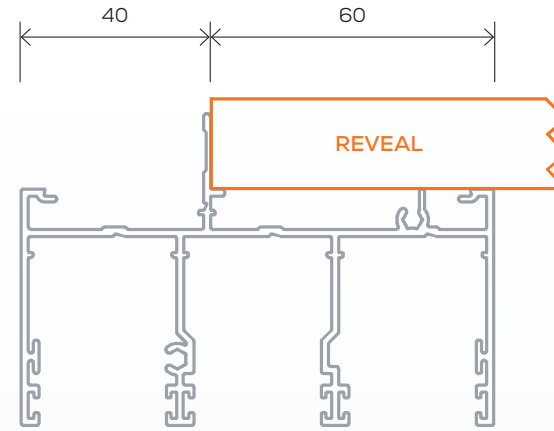

Signature Sliding Window (100mm)

# SILL REBATES

Note: Diagrams are not to scale

## Essential Sliding Window 52

2011 SILL 150Pa

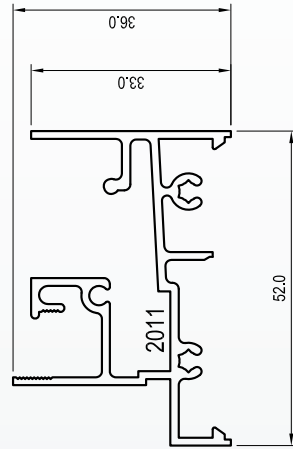

3341 SILL 450Pa

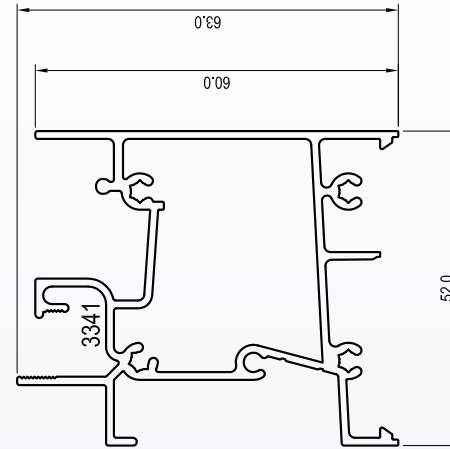

# SILL REBATES

Note: Diagrams are not to scale

## Essential Sliding Window 52

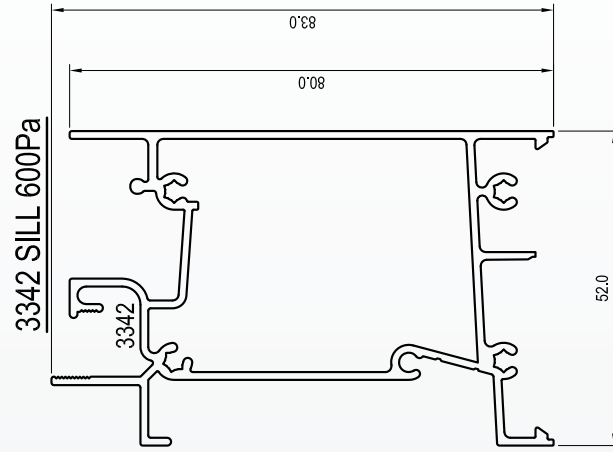

3341 SILL 450Pa WITH 2925 SUBSILL '35' 52

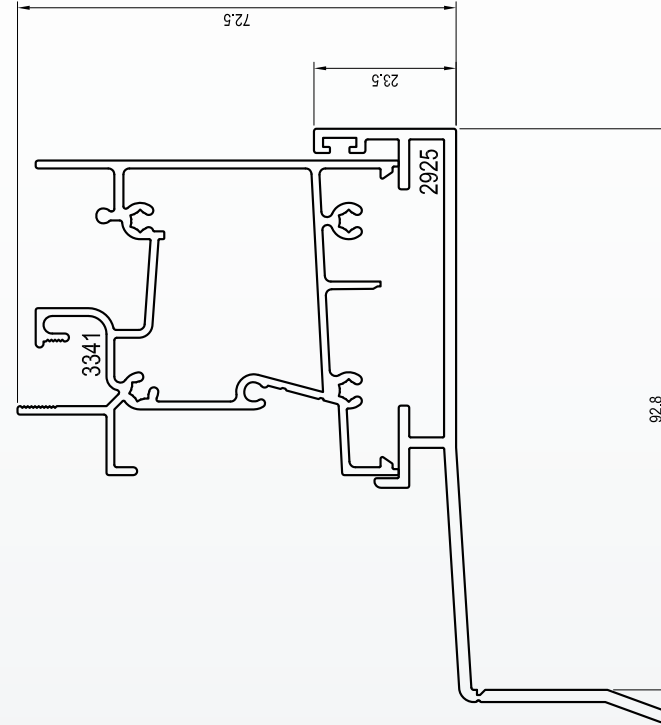

# SILL REBATES

Note: Diagrams are not to scale

## Essential Sliding Window 52

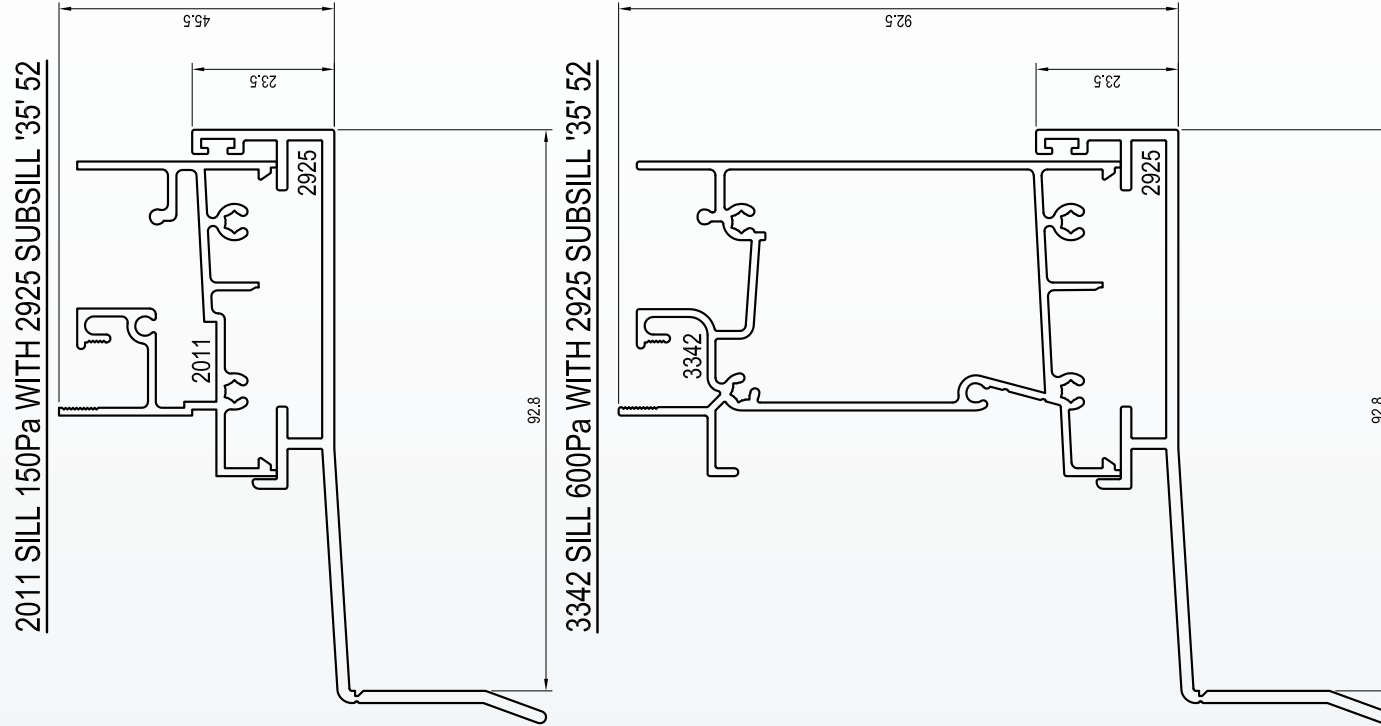

# SILL REBATES

Note: Diagrams are not to scale

## Signature Sliding Window 67

3187 SILL 2 TRACK FINLESS

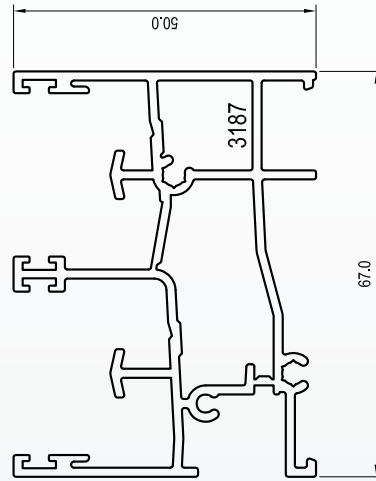

3171 SILL 2 TRACK HP

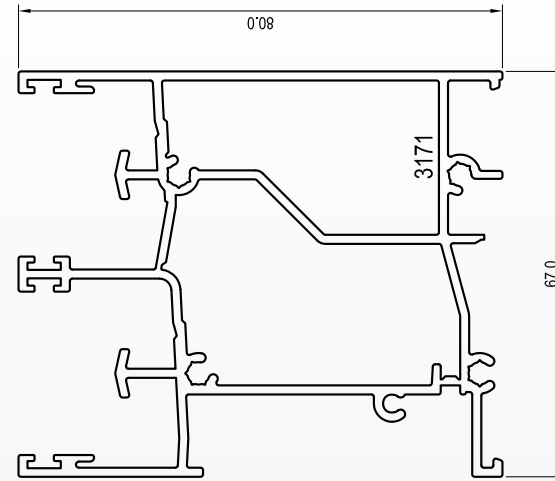

# SILL REBATES

Note: Diagrams are not to scale

## Signature Sliding Window 67

3187 SILL 2 TRACK FINLESS WITH 3167 SUBSILL '15' 67

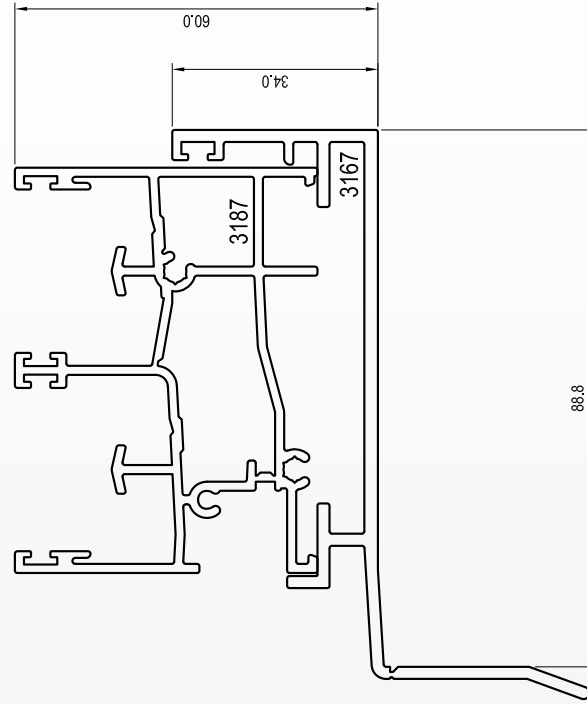

3187 SILL 2 TRACK FINLESS WITH 3169 SUBSILL '35' 67

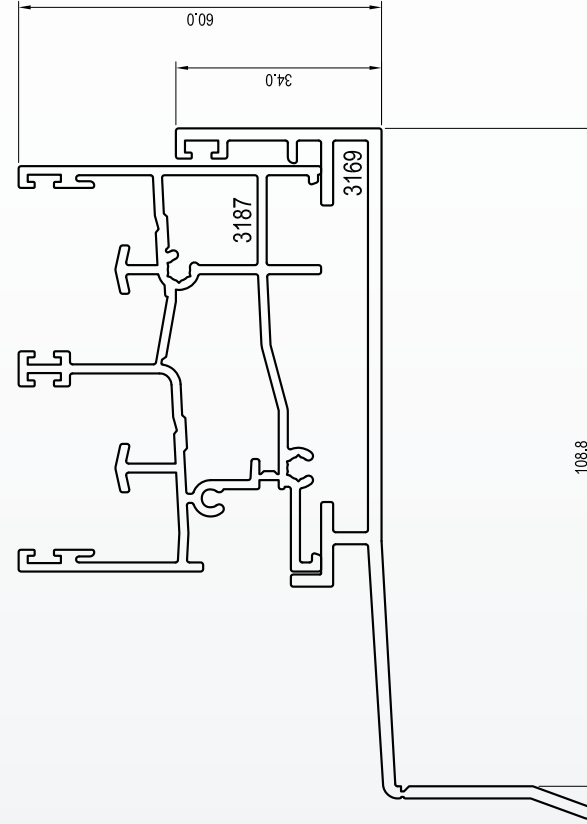

# SILL REBATES

Note: Diagrams are not to scale

## Signature Sliding Window 67

3171 SILL 2 TRACK HP WITH 3167 SUBSILL '15' 67

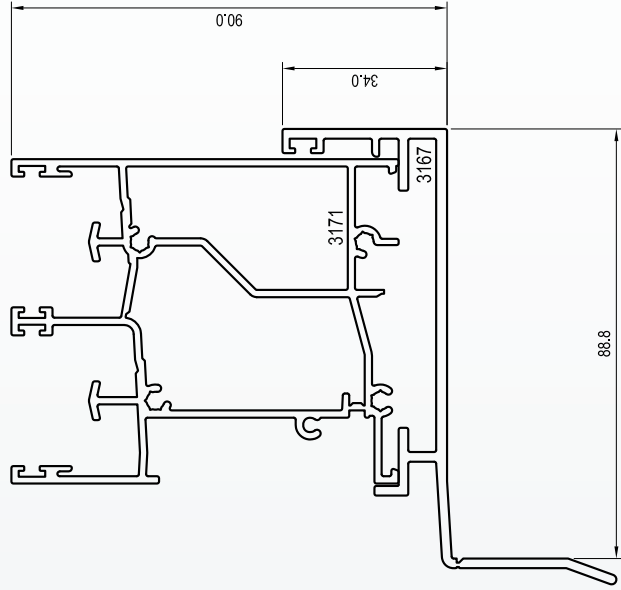

3171 SILL 2 TRACK HP WITH 3169 SUBSILL '35' 67

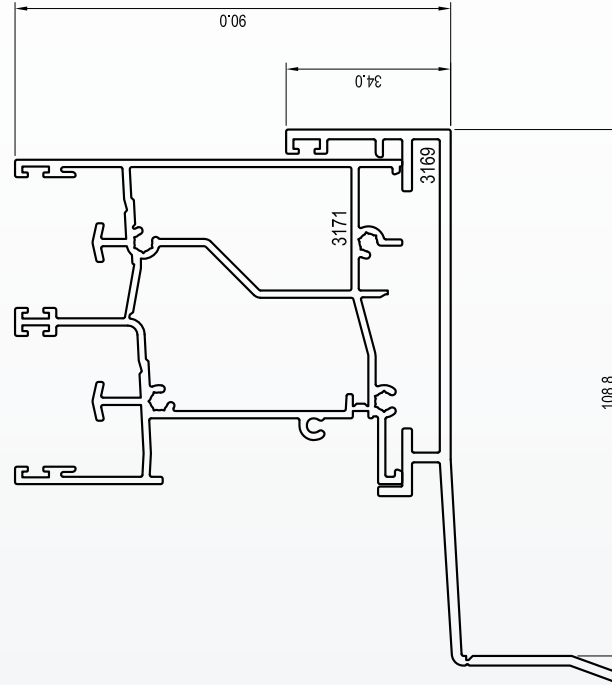



# SILL REBATES

Note: Diagrams are not to scale

## Signature Sliding Window 67

3173 SILL CP 67 WITH 3167 SUBSILL '15' 67

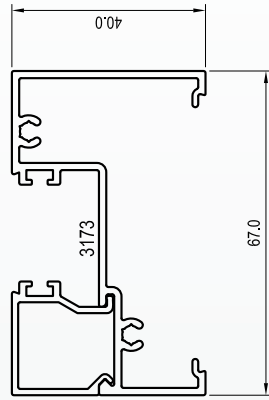

3173 SILL CP 67 WITH 3167 SUBSILL '15' 67

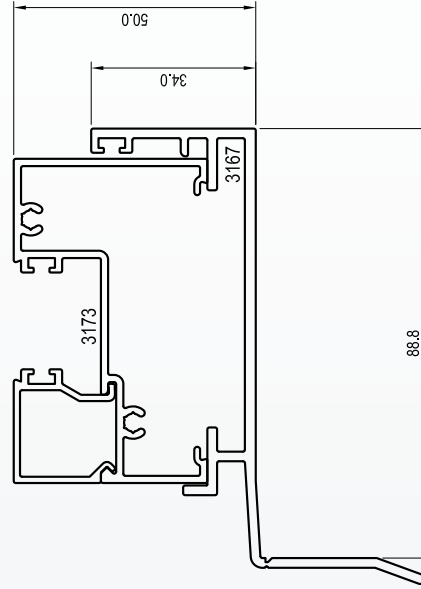

3173 SILL CP 67 WITH 3169 SUBSILL '35' 67

