

BRADNAM'S

SIZE RANGE  
CATALOGUE

VICTORIA



**Bradnam's**  
windows & doors

# Design Styles WINDOWS AND DOORS

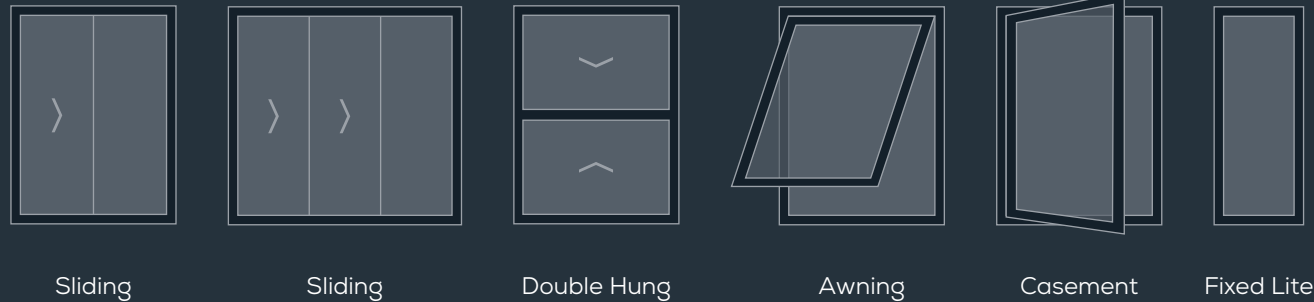

Sliding

Sliding

Double Hung

Awning

Casement

Fixed Lite

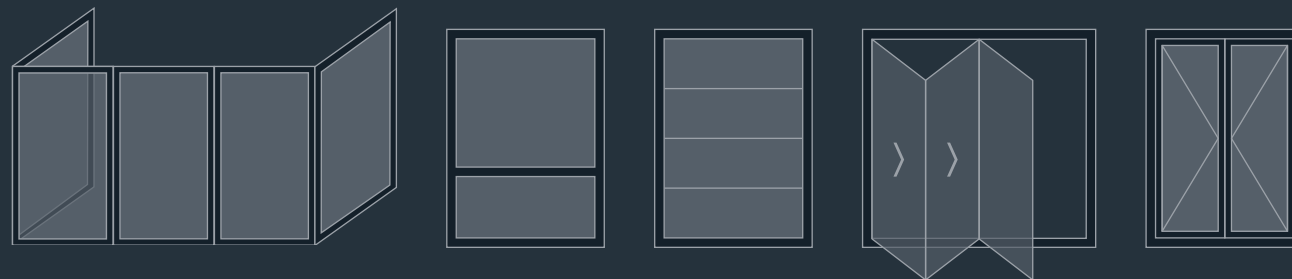

90° Bay Window

Transom Window

Louvre

Bi-fold

Hinged



135° Bay Window

Rake

Circle

Arch

## Important Information

- All diagrams shown as viewed from the exterior.
- All measurements are in millimetres and are coded for ordering purposes.
- Height is always indicated first – sizes are finished sizes and do not include building-in fin.
- Please state left or right-hand opening as viewed from the exterior of the building when ordering.
- Timber reveal lining is available.
- Timber reveal lining is not fitted to the door sill.
- Building in and prepared opening ties are available for both window and door products.
- All doors are fitted with safety glass and motif.
- Large windows may need motif. Confirm with a Bradnam's sales representative.
- Heavy duty sections may be used depending on the product size and required wind pressure.
- Non-standard sizes and configurations are available on request.

## Colonial Bar Options



SF1218  
Traditional Colonial

SF1218  
Australian Colonial

SF1218  
Highlander



SF1218  
Traditional Federation



SF1218  
Australian Federation

# Product Care GUIDE

## Maintenance of Powder Coated Aluminium Finishes

- In a rural atmosphere, cleaning may not be needed more frequently than every 6 months.
- In industrial and marine environments, more frequent cleaning (e.g. monthly, every 3 months is necessary).
- **It is critical** that non-abrasive mild detergent solution is used for cleaning.
- Add the non-abrasive mild detergent solution to a bucket of warm water.
- Wet a clean, soft rag then wipe the aluminium.
- Make sure that the surfaces are thoroughly rinsed after cleaning to remove all residues.

## Maintenance of Window and Door Glass

- All glass surfaces should be kept clean by prompt removal of all dirt.
- Use clean water and soft, clean rag as buttons or grit can scratch the glass.
- In some instances, a small amount of mild detergent may be of some benefit. However, **DO NOT** use any form of abrasive cleaner or household cleaners.
- When using detergent make sure that the surfaces are rinsed well after cleaning to remove any detergent residue.

### Special instructions for Solar Comfort glass, and other Low-E coated glass products

- The special coating on these types of glass is generally more difficult to clean.
- Use only soft, clean cloth, free from grit or buttons with a mild soap or detergent and water or recommended glass cleaner solution.
- Make sure to dry off excess water.
- **DO NOT** use abrasive cleaning agents.

Refer to our Solar Comfort Cleaning Recommendations document for more information.

## Maintenance of Hardware

- General periodic maintenance is required on all hardware supplied such as locks, hinges, catches, closers and the like.
- The external finish of hardware must be kept clean by removing any harmful residue (especially salt spray) from the surface using a non-abrasive cleaning agent.
- Internal mechanisms of locks, catches, etc should be kept in good working order by applying a light spray of lubricant (WD40, RP7 or similar).
- **Care should be taken** during maintenance of internal mechanisms that any finished surface (eg. paint etc) is well protected to avoid damage.

## Maintenance of Window and Door Rollers

- Remove the sliding panel of the product from the inside of the house. With the window or door partly open, lift the sliding panel up into the head while tilting the bottom of the panel towards you, out over the sill. Slide the panel downwards to remove it from the frame.
- Use a vacuum cleaner with a narrow nozzle to clean the track thoroughly.
- Use a soft rag and water mixed with mild detergent to wipe the track and rollers.
- It is essential that rollers are cleaned 3-4 times a year.

## Maintenance of Insect and Safety Screens

- Clean screens 3-4 times a year.
- Add a small amount of mild detergent to a bucket of warm water.
- Remove the screen from the window.
- Hose the screen down thoroughly. Dip a soft nylon brush into the bucket of water and gently brush the screen.
- Hose down well.
- Allow the screen to dry before replacing in the window.

## Maintenance of Stainless View™ and Ali-View™ Screens

































































- Stainless View™ and Ali-View™ screens should be cleaned at frequent intervals as indicated in the table below.
- It is important that non-abrasive mild detergent solution combined with warm water, and a clean, soft, non-abrasive cloth, are used for cleaning.
- Hand cleaning is recommended except for multi-storey buildings and large commercial projects where carefully controlled methods to loosen deposits of dirt and grime are required.
- It is essential to finish off the cleaning by thoroughly rinsing all surfaces to remove all residue.
- Fibre brushes may be used to loosen dirt and grime, but abrasive papers such as sand paper or emery paper **MUST NOT** be used.

## Recommended Maintenance Intervals

Type of Environment	Definition of Environment	Maximum Maintenance Intervals
Mild	Being rural, away from the coast and remote industry and urban activity.	6 Months
Moderate	Being mainly urban, inland and away from heavy industrial activity.	3 Months
Tropical / Severe	Being coastal/marine, subject to salt deposition and within 15km of the eastern coast or 10km of the western coast of Australia.	2-4 Weeks

# Sliding Windows STANDARD SIZES

The availability of certain sizes and configurations is dependent on the design wind load requirement as per AS2047-2014. Check with your Bradnam's representative to confirm availability. Sliding Windows may be subject to local variation or regulatory requirements.

STUD OPENING mm		670	910	1270	1510	1870	2230	2230	2470	2710	3070
FRAME SIZE mm		610	850	1210	1450	1810	2170	2170	2410	2650	3010
660	600	 SF0606	 SF0609	 SF0612	 SF0615	 SF0618	 SF0621	 SFS0621	 SFS0624	 SFS0627	 SFS0630
	920	 SF0906	 SF0909	 SF0912	 SF0915	 SF0918	 SF0921	 SFS0921	 SFS0924	 SFS0927	 SFS0930
1090	1030	 SF1006	 SF1009	 SF1012	 SF1015	 SF1018	 SF1021	 SFS1021	 SFS1024	 SFS1027	 SFS1030
1260	1200	 SF1209	 SF1212	 SF1215	 SF1218	 SF1221	 SFS1221	 SFS1224	 SFS1227	 SFS1230	
	1520	1460	 SF1409	 SF1412	 SF1415	 SF1418	 SF1421	 SFS1421	 SFS1424	 SFS1427	 SFS1430
1860	1800	 SF1809T	 SF1812T	 SF1815T	 SF1818T	 SF1821T	 SFS1821T	 SFS1824T	 SFS1827T	 SFS1830T	
	2120	2060	 SF2012T	 SF2015T	 SF2018T	 SF2021T	 SFS2021T	 SFS2024T	 SFS2027T	 SFS2030T	

Viewed from exterior: **S** = Sliding Panel, **F** = Fixed Panel













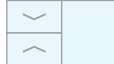
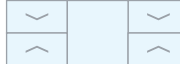

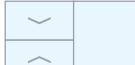
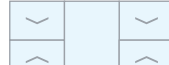
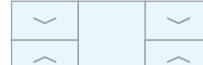

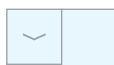

Arrow indicates sliding direction viewed from exterior

Sliding Windows are also available in FS or FSSF configurations (minimum of 1810mm in width required)





























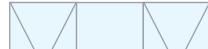
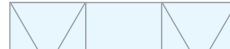







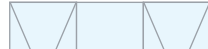
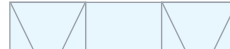





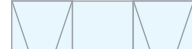

















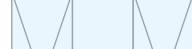









# Double Hung Windows STANDARD SIZES

The availability of certain sizes and configurations is dependent on the design wind load requirement as per AS2047-2014. Check with your Bradnam's representative to confirm availability. Double Hung Windows may be subject to local variation or regulatory requirements.

STUD OPENING mm		670	910	1270	1510	1870	2230	2470	2710	3070
FRAME SIZE mm		610	850	1210	1450	1810	2170	2410	2650	3010
920	860	 D0906	 D0909	 D0912	 DF0915	 DF0918	 DFD0921	 DFD0924	 DFD0927	 DFD0930
	1090	 D1006	 D1009	 D1012	 DF1015	 DF1018	 DFD1021	 DFD1024	 DFD1027	 DFD1030
1260	1200	 D1206	 D1209	 D1212	 DF1215	 DF1218	 DFD1221	 DFD1224	 DFD1227	 DFD1230
	1520	 D1406	 D1409	 D1412	 DF1415	 DF1418	 DFD1421	 DFD1424	 DFD1427	 DFD1430
1860	1800	 D1806	 D1809	 DF1812	 DF1815	 DF1818	 DFD1821	 DFD1824	 DFD1827	
	2120	 D2006	 D2009	 DF2012	 DF2015	 DF2018	 DFD2021	 DFD2024	 DFD2027	

# Awning Windows STANDARD SIZES

The availability of certain sizes and configurations is dependent on the design wind load requirement as per AS2047-2014. Check with your Bradnam's representative to confirm availability. Awning Windows may be subject to local variation or regulatory requirements.



















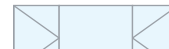



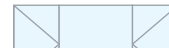
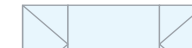

















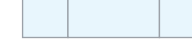

STUD OPENING mm		670	910	1270	1510	1870	2230	2470	2710	3070
FRAME SIZE mm		610	850	1210	1450	1810	2170	2410	2650	3010
660	600	 A0606	 A0609	 AF0612	 AF0615	 AF0618	 AFA0621	 AFA0624	 AFA0627	 AFA0630
	920	 A0906	 A0909	 AF0912	 AF0915	 AF0918	 AFA0921	 AFA0924	 AFA0927	 AFA0930
1090	1030	 A1006	 A1009	 AF1012	 AF1015	 AF1018	 AFA1021	 AFA1024	 AFA1027	 AFA1030
	1260	 A1206	 A1209	 AF1212	 AF1215	 AF1218	 AFA1221	 AFA1224	 AFA1227	 AFA1230
1520	1460	 A1406	 A1409	 AF1412	 AF1415	 AF1418	 AFA1421	 AFA1424	 AFA1427	 AFA1430
	1860	 A1806T	 A1809T	 AF1812T	 AF1815T	 AF1818T	 AFA1821T	 AFA1824T	 AFA1827T	 AFA1830T
2120	1800	 A1806T	 A1809T	 AF1812T	 AF1815T	 AF1818T	 AFA1821T	 AFA1824T	 AFA1827T	 AFA1830T
	2060	 A2006T	 A2009T	 AF2012T	 AF2015T	 AF2018T	 AFA2021T	 AFA2024T	 AFA2027T	 AFA2030T

**Note:** All Awning Window sashes come standard with a lockable chain winder

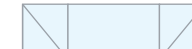
# Casement Windows STANDARD SIZES

The availability of certain sizes and configurations is dependent on the design wind load requirement as per AS2047-2014. Check with your Bradnam's representative to confirm availability. Casement Windows may be subject to local variation or regulatory requirements.



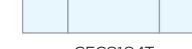







## ESSENTIAL

STUD OPENING mm		670	910	1270	1510	1870	2230	2470
FRAME SIZE mm		610	850	1210	1450	1810	2170	2410
660	600	 C0606	 CF0609	 CF0612	 CFC0616	 CFC0618	 CFC0621	 CFC0624
	920	 C0906	 CF0909	 CF0912	 CFC0916	 CFC0918	 CFC0921	 CFC0924
1090	1030	 C1006	 CF1009	 CF1012	 CFC1016	 CFC1018	 CFC1021	 CFC1024
1260	1200	 C1206	 CF1209	 CF1212	 CFC1216	 CFC1218	 CFC1221	 CFC1224
1520	1460	 C1506	 CF1509	 CF1512	 CFC1516	 CFC1518	 CFC1521	 CFC1524
1860	1800	 C1806T	 CF1809T	 CF1812T	 CFC1816T	 CFC1818T	 CFC1821T	 CFC1824T
	600	 C1806T	 CF1809T	 CF1812T	 CFC1816T	 CFC1818T	 CFC1821T	 CFC1824T
2120	2060	 C2106T	 CF2109T	 CF2112T	 CFC2116T	 CFC2118T	 CFC2121T	 CFC2124T
	600	 C2106T	 CF2109T	 CF2112T	 CFC2116T	 CFC2118T	 CFC2121T	 CFC2124T

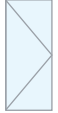
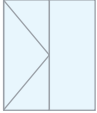
# Casement Windows STANDARD SIZES

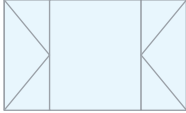
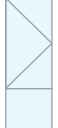
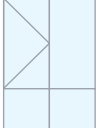
The availability of certain sizes and configurations is dependent on the design wind load requirement as per AS2047-2014. Check with your Bradnam's representative to confirm availability. Louvre Windows may be subject to local variation or regulatory requirements.

## SIGNATURE LB

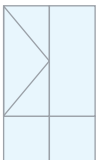
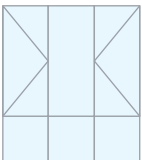
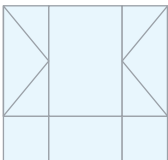
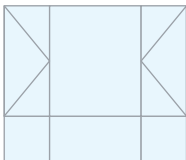
STUD OPENING mm		710	1270	1870	2230	2470
FRAME SIZE mm		650	1210	1810	2170	2410
1260	1200	 C1206	 CF1212	 CFC1218	 CFC1221	 CFC1224
	1520	 C1506	 CF1512	 CFC1518	 CFC1521	 CFC1524
1860	1800	 C1806T	 CF1812T	 CFC1818T	 CFC1821T	 CFC1824T
	2120	 C2106T	 CF2112T	 CFC2118T	 CFC2121T	 CFC2124T



# Bi-fold Windows STANDARD SIZES

The availability of certain sizes and configurations is dependent on the design wind load requirement as per AS2047-2014. Check with your Bradnam's representative to confirm availability. Bi-fold Windows may be subject to local variation or regulatory requirements.

STUD OPENING mm		1390	1630	1750	2750	3170	3430	4370	4850	6010	
FRAME SIZE mm		1330	1570	1690	2690	3110	3370	4310	4790	5050	
		2 LITE			4 LITE			6 LITE			
660	600										
920	860										
1090	1030										
1260	1200										
1430	1370										
1520	1460										
	220										
	202										
	404										
	660										

### Bi-Fold Numbering

eg: **422** (exterior view from left to right)

4	2	2
Total panels	No of panels opening to left	No of panels opening to right

# Bay Windows STANDARD SIZES

The availability of certain sizes and configurations is dependent on the design wind load requirement as per AS2047-2014. Check with your Bradnam's representative to confirm availability. Bay Windows may be subject to local variation or regulatory requirements.

## 90° Bay Window Setout

Width of window	<b>A</b>	=	Slab dimension A - 300mm
Width of window	<b>B</b>	=	Slab dimension B - 150mm
Width of window	<b>C</b>	=	Slab dimension C - 150mm

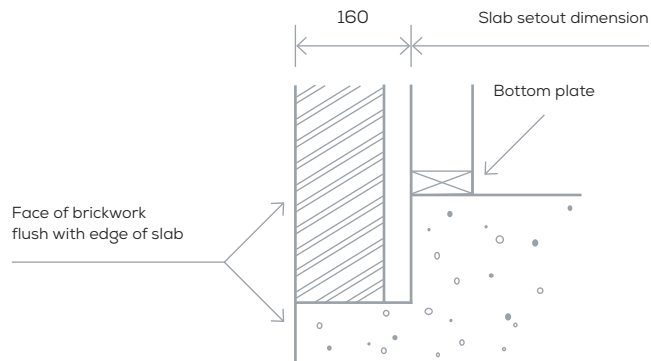





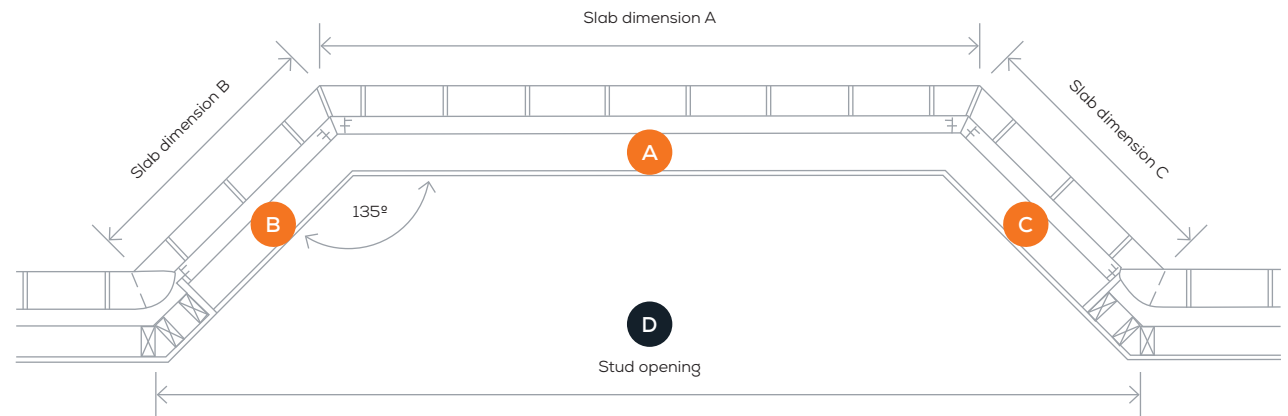











## 135° Bay Window Setout

Width of window	<b>A</b>	=	Slab dimension A - 140mm
Width of window	<b>B</b>	=	Slab dimension B - 160mm
Width of window	<b>C</b>	=	Slab dimension C - 160mm
Stud opening	<b>D</b>	=	$(2 \times \text{Slab dimension B} \times 0.7071) + \text{Slab dimension A} - 130\text{mm}$ where B and C are equal
Depth of Bay window	<b>E</b>	=	Slab dimension B or C x 0.7071

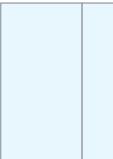

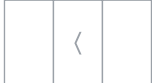
# Sliding Doors STANDARD SIZES

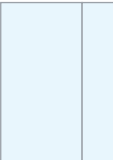
The availability of certain sizes and configurations is dependent on the design wind load requirement as per AS2047-2014. Check with your Bradnam's representative to confirm availability. Sliding Doors may be subject to local variation or regulatory requirements.

STUD OPENING mm		1510	1870	2230	2470	2770	
FRAME SIZE mm		1450	1810	2170	2410	2710	
2130	2100						Also available in FS configuration 
		SF2115	SF2118	SF2122	SF2124	SF2127	
2430	2400						
		SF2415	SF2418	SF2421	SF2424	SF2427	
STUD OPENING mm		2208	2748	3288	3648	4098	
FRAME SIZE mm		2148	2688	3228	3588	4038	
2130	2100						Also available in FSFL configuration 
		FSFR2122	FSFR2127	FSFR2132	FSFR2136	FSFR2140	
2430	2400						
		FSFR2422	FSFR2427	FSFR2432	FSFR2436	FSFR2440	

Viewed from exterior: **S** = Sliding Panel, **F** = Fixed Panel      Arrow indicates sliding direction viewed from exterior

# Sliding Doors STANDARD SIZES

The availability of certain sizes and configurations is dependent on the design wind load requirement as per AS2047-2014. Check with your Bradnam's representative to confirm availability. Sliding Doors may be subject to local variation or regulatory requirements.

STUD OPENING mm		2208	2748	3288	3648	4098	
FRAME SIZE mm		2148	2688	3228	3588	4038	
2130	2100						Also available in FSS configuration 
		SSF2122	SSF2127	SSF2132	SSF2136	SSF2140	
2430	2400						
		SSF2422	SSF2427	SSF2432	SSF2436	SSF2440	
STUD OPENING mm		2924	3644	4364	4844	5444	
FRAME SIZE mm		2864	3584	4304	4784	5384	
2130	2100						
		FSSF2129	FSSF2136	FSSF2143	FSSF2148	FSSF2154	
2430	2400						
		FSSF2429	FSSF2436	FSSF2443	FSSF2448	FSSF2454	

Viewed from exterior: S = Sliding Panel, F = Fixed Panel

Arrow indicates sliding direction viewed from exterior

# Sliding Doors STANDARD SIZES

The availability of certain sizes and configurations is dependent on the design wind load requirement as per AS2047-2014. Check with your Bradnam's representative to confirm availability. Sliding Doors may be subject to local variation or regulatory requirements.

STUD OPENING mm		4326	5406	6306
FRAME SIZE mm		4266	5346	6246
2130	2100	 FSSSSF2143	 FSSSSF2153	 FSSSSF2162
	2400	 FSSSSF2443	 FSSSSF2453	 FSSSSF2462

Viewed from exterior: **S** = Sliding Panel, **F** = Fixed Panel

Arrow indicates sliding direction viewed from exterior

# Bi-fold Doors STANDARD SIZES

The availability of certain sizes and configurations is dependent on the design wind load requirement as per AS2047-2014. Check with your Bradnam's representative to confirm availability. Bi-fold Doors may be subject to local variation or regulatory requirements.

STUD OPENING mm		1390	1630	1750	1870	2390	2590	2750	3170	3430	3170	3650	4270	4370	4850	5110
FRAME SIZE mm		1330	1570	1690	1810	2330	2530	2690	3110	3370	3110	3590	4210	4310	4790	5050
		2 LITE		3 LITE			4 LITE			5 LITE			6 LITE			
2140	2100															
	2440															
220																
202																
440																
431																
422																
413																
404																
550																
505																
660																
651																
633																
624																
606																
615																

## Bi-Fold Numbering

eg: **321** (exterior view from left to right)

3	2	1
Total panels	No of panels opening to left	No of panels opening to right

**Note:** 2 Lite, 4 Lite and 6 Lite configurations do not have an access door panel

# Hinged Doors STANDARD SIZES

The availability of certain sizes and configurations is dependent on the design wind load requirement as per AS2047-2014. Check with your Bradnam's representative to confirm availability. Hinged Doors may be subject to local variation or regulatory requirements.

## Standard Configurations

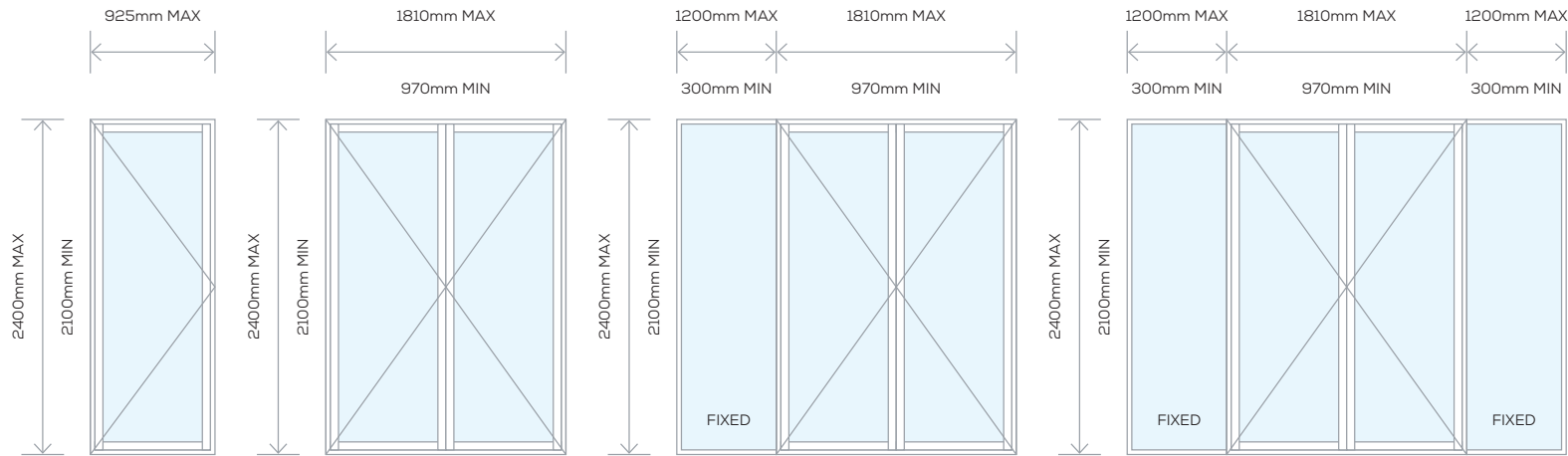

## Hinged Door Information

- Standard door leaf widths are 620mm, 720mm, 820mm
- Maximum leaf size 870mm
- All doors to be supplied with sills
- Operable windows are available as side lites if required
- Hi lites are available subject to confirmation of structural performance

## Frame Only Configurations

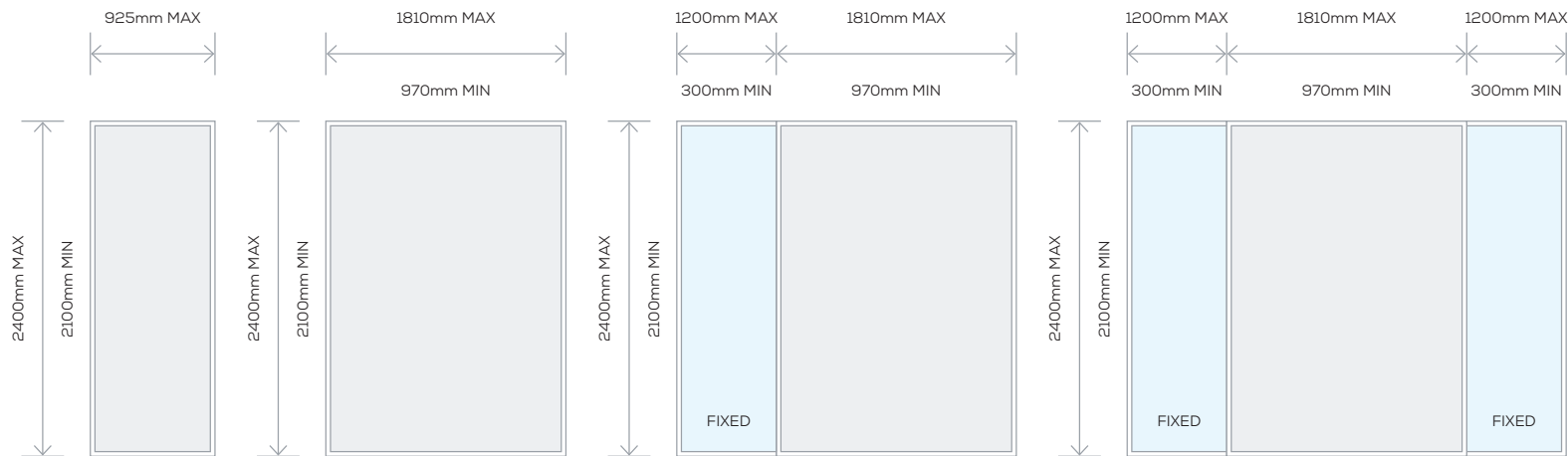

# Bradnam's 7 Year Guarantee TERMS & CONDITIONS

Bradnam's Windows & Doors Pty Ltd is a member of the Australian Window Association and as such conforms to an Industry Code of Conduct designed to protect consumers.

Subject to the conditions and limitations below Bradnam's Windows and Doors Pty Ltd guarantees its products against defects arising from faulty workmanship or materials for seven years from the date of delivery or installation.

For the purpose of this warranty "the product" can mean a window, door, insect screen, safety screen, Stainless View™ screen, Ali-View™ screen, shower screen, glass splashback, mirror, wardrobe door or shelving product ordinarily manufactured and sold by Bradnam's Windows and Doors Pty Ltd.

## Conditions and Limitations

- 1 The product is installed in accordance with the relevant Australian Standards and building practice. Unless otherwise specifically confirmed in writing, Bradnam's Windows and Doors Pty Ltd accepts no responsibility for waterproofing and/or re-sealing of penetrations and such remains the responsibility of others.
- 2 The product has been maintained according to Bradnam's Windows and Doors Pty Ltd maintenance recommendations and has not been subject to misuse, physical abuse, or neglect.
- 3 In respect of window and door products, this guarantee is void if Bradnam's Windows and Doors Pty Ltd insect screens, safety screens, Stainless View™ screens and Ali-View™ screens have not been manufactured and fitted by Bradnam's Windows and Doors Pty Ltd installers or personnel nominated by Bradnam's Windows and Doors Pty Ltd.

- 4 Manufacturing standards and tolerances are not deemed defects, nor are industry variations in the colour of aluminium componentry and glass.
- 5 Bradnam's Windows and Doors Pty Ltd accepts no responsibility for glass breakage (except for faulty workmanship or materials). Wire reinforced glass, toughened glass, float glass, laminated glass, mirror glass, framed mirror glass and painted glass is guaranteed against defects and degradation (e.g. desilvering) for one (1) year.
- 6 Moving parts, where applicable, which wear out as part of normal use are guaranteed for one (1) year.
- 7 This guarantee is limited to the repair or replacement of the faulty product at the company's discretion but does not extend to the installation or refurbishing of a replacement product or any other consequential or indirect damage incurred as a result of the defect. Only repairs carried out by Bradnam's Windows and Doors Pty Ltd personnel or authorised Bradnam's Windows and Doors Pty Ltd agents are covered by this guarantee.
- 8 This guarantee is in addition to all other rights and remedies in respect of this product to which you are entitled under the *Competition and Consumer Act 2010 (Cth)*.

## Warranty Claims

Claims under this guarantee must be made within one month of the defect arising in the product. Other than as provided by law Bradnam's Windows and Doors Pty Ltd will repair or replace the product to the extent that it is functionally equivalent to the original product supplied.

Copies of documentation showing the purchase date of the product should be included with your written claim and forwarded to the nearest Bradnam's Windows and Doors Pty Ltd office. All warranty claims will initially require a deposit to be paid. After inspection by Bradnam's Windows and Doors Pty Ltd personnel or authorised agents, the customer will be advised if the claim is covered under the warranty. If the claim is under warranty the deposit will be refunded and the product will be repaired or replaced by Bradnam's Windows and Doors Pty Ltd. Otherwise, upon the customer's request, Bradnam's Windows and Doors Pty Ltd will provide a quote to rectify the problem.

For more information call Bradnam's on  
**1300 WINDOWS 1300 946369**  
or visit [bradnams.com.au](http://bradnams.com.au)



/bradnams



/bradnamswindowsdoors



/company/bradnams-windows-and-doors



/bradnamswindowsanddoors

## WINDOWS & DOORS

## INSECT & SAFETY SCREENS



### Australian Owned & Made

Bradnam's products are proudly made in Australia and designed specifically to meet all Australian conditions.

Product availability, pricing, features, options, sizes, configurations and performance are subject to regional variations, design requirements and building codes.

Images are for illustration purposes only and may not accurately represent the product. Bradnam's Windows & Doors reserves the right to change, alter or delete any aspect of this product without notice.

We recommend visiting a Bradnam's showroom before ordering to view colour swatches, glass samples and actual products.



Bradnam's Windows and Doors . QBCC Act lic 58885  
© Bradnam's Windows and Doors . v10 Nov 2019

